

ALLIANT ENERGY
Wisconsin Power and Light Company
Edgewater Generating Station

CCR SURFACE IMPOUNDMENT

HISTORY OF CONSTRUCTION

Report Issued: September 21, 2016
Revision 0



EXECUTIVE SUMMARY

This History of Construction (Report) is prepared in accordance with the requirements of the United States Environmental Protection Agency (USEPA) published Final Rule for Hazardous and Solid Waste Management System – Disposal of Coal Combustion Residual (CCR) from Electric Utilities (40 CFR Parts 257 and 261, also known as the CCR Rule) published on April 17, 2015 and effective October 19, 2015.

This Report documents the construction history of each CCR unit at Edgewater Generating Station in Sheboygan, Wisconsin in accordance with §257.73(c) of the CCR Rule. For purposes of this Report, the term “CCR unit” only refers to existing CCR surface impoundments.

Primarily, this Report is focused on providing history of construction information for each CCR surface impoundment to the extent feasible, provided that that such information is reasonably and readily available.



Table of Contents

1	INTRODUCTION	1
1.1	CCR Rule Applicability	1
1.2	History of Construction Applicability	1
2	FACILITY DESCRIPTION	2
2.1	Name and Address - §257.73(c)(1)(i)	2
2.2	General Facility History	2
3	HISTORY OF CONSTRUCTION - §257.73(c)(1).....	9
3.1	EDG Slag Pond.....	9
3.1.1	CCR Unit Location - §257.73(c)(1)(ii).....	9
3.1.2	Statement of Purpose - §257.73(c)(1)(iii).....	9
3.1.3	Physical Layout Information - §257.73(c)(1)(iv)	10
3.1.4	Foundation and Abutment Properties - §257.73(c)(1)(v)	11
3.1.5	Historical Construction and Use - §257.73(c)(1)(vi).....	11
3.1.6	Structures, Appurtenances, and Operations- §257.73(c)(1)(vii).....	15
3.1.7	Instrumentation - §257.73(c)(1)(viii)	16
3.1.8	Area-Capacity Curve - §257.73(c)(1)(ix).....	16
3.1.9	Spillway and Diversion Features - §257.73(c)(1)(x).....	16
3.1.10	Construction Specifications, Surveillance, Maintenance, and Repair - §257.73(c)(1)(xi)...	16
3.1.11	Structural Instability Records - §257.73(c)(1)(xii).....	17
3.2	EDG North A-Pond.....	17
3.2.1	CCR Unit Location - §257.73(c)(1)(ii).....	18
3.2.2	Statement of Purpose - §257.73(c)(1)(iii).....	18
3.2.3	Physical Layout Information - §257.73(c)(1)(iv)	18
3.2.4	Foundation and Abutment Properties - §257.73(c)(1)(v)	19
3.2.5	Historical Construction and Use - §257.73(c)(1)(vi).....	19
3.2.6	Structures, Appurtenances, and Operations- §257.73(c)(1)(vii).....	23
3.2.7	Instrumentation - §257.73(c)(1)(viii)	24
3.2.8	Area-Capacity Curve - §257.73(c)(1)(ix).....	24
3.2.9	Spillway and Diversion Features - §257.73(c)(1)(x).....	24
3.2.10	Construction Specifications, Surveillance, Maintenance, and Repair - §257.73(c)(1)(xi)...	25
3.2.11	Structural Instability Records - §257.73(c)(1)(xii).....	26
3.3	EDG South A-Pond.....	26
3.3.1	CCR Unit Location - §257.73(c)(1)(ii).....	26
3.3.2	Statement of Purpose - §257.73(c)(1)(iii).....	26
3.3.3	Physical Layout Information - §257.73(c)(1)(iv)	27
3.3.4	Foundation and Abutment Properties - §257.73(c)(1)(v)	28
3.3.5	Historical Construction and Use - §257.73(c)(1)(vi).....	29
3.3.6	Structures, Appurtenances, and Operations- §257.73(c)(1)(vii).....	32



3.3.7	Instrumentation - §257.73(c)(1)(viii)	33
3.3.8	Area-Capacity Curve - §257.73(c)(1)(ix).....	33
3.3.9	Spillway and Diversion Features - §257.73(c)(1)(x).....	34
3.3.10	Construction Specifications, Surveillance, Maintenance, and Repair - §257.73(c)(1)(xi)...	34
3.3.11	Structural Instability Records - §257.73(c)(1)(xii).....	35
3.4	EDG B-Pond	35
3.4.1	CCR Unit Location - §257.73(c)(1)(ii).....	35
3.4.2	Statement of Purpose - §257.73(c)(1)(iii).....	36
3.4.3	Physical Layout Information - §257.73(c)(1)(iv).....	36
3.4.4	Foundation and Abutment Properties - §257.73(c)(1)(v).....	37
3.4.5	Historical Construction and Use - §257.73(c)(1)(vi).....	38
3.4.6	Structures, Appurtenances, and Operations- §257.73(c)(1)(vii).....	40
3.4.7	Instrumentation - §257.73(c)(1)(viii).....	41
3.4.8	Area-Capacity Curve - §257.73(c)(1)(ix).....	41
3.4.9	Spillway and Diversion Features - §257.73(c)(1)(x).....	42
3.4.10	Construction Specifications, Surveillance, Maintenance, and Repair - §257.73(c)(1)(xi)...	42
3.4.11	Structural Instability Records - §257.73(c)(1)(xii).....	43
4	CHANGES TO THE HISTORY OF CONSTRUCTION.....	44

Figures

Figure 1: Site Location

Figure 2: Hydraulic Routing

Appendices

Appendix A: Edgewater Ash Disposal Site – 1976

Appendix B: EDR Historical Aerial Photograph Package

Appendix C: EDR Historical Topographic Map Report

Appendix D: Geoprobe Soil Borings – 2010

Appendix E: EDG Existing CCR Surface Impoundment Drawings



1 INTRODUCTION

The owner/operator of the CCR units must provide a history of construction for the existing CCR surface impoundments at Edgewater Generating Station (EDG) in Sheboygan, Wisconsin in accordance with §257.73(c)(1) of the CCR Rule. Hard Hat Services, on behalf of Wisconsin Power and Light Company, has provided history of construction information for the existing CCR surface impoundments to the extent feasible, provided that such information is reasonably and readily available.

1.1 CCR Rule Applicability

The CCR Rule requires that an owner/operator of the CCR unit must provide a history of construction for existing CCR surface impoundments with a height of 5 feet or more and a storage volume of 20 acre-feet or more (§257.73(b)(1)); or the existing CCR surface impoundment has a height of 20 feet or more (§257.73(b)(2)).

1.2 History of Construction Applicability

EDG has four existing CCR surface impoundments, which meets the requirements of §257.73(b)(1) and/or §257.73(b)(2), identified as follows:

- EDG Slag Pond
- EDG North A-Pond
- EDG South A-Pond
- EDG B-Pond



2 FACILITY DESCRIPTION

The following sub-sections provide a general facility description.

2.1 Name and Address - §257.73(c)(1)(i)

Included below is the name and address of the owner/operator of the CCR unit, name of the CCR unit, and state identification number for the CCR Unit (if one has been assigned by the state).

Owner/Operator Name and Address:

Wisconsin Power and Light Company (*an Alliant Energy Company*)
Edgewater Generating Station
3739 Lakeshore Drive
Sheboygan, WI 53081

The names of the existing CCR Units located at EDG are identified as follows:

- EDG Slag Pond
- EDG North A-Pond
- EDG South A-Pond
- EDG B-Pond

No state identification numbers have been assigned to the CCR units at EDG.

2.2 General Facility History

EDG is located on the south edge of the City of Sheboygan, Wisconsin along the western shore of Lake Michigan in Sheboygan County. Figure 1 provides both a topographic map and an aerial photograph of the EDG facility location, with the approximate property boundary of the facility identified.

EDG, originally owned and operated by the Wisconsin Power and Light Company, initiated facility operations in 1930. At the time of initial operations EDG was a fossil-fueled electric generating station that consisted of one steam electric generating unit (Unit 1) which burned coal as its primary fuel source. The initial steam electric generating unit at EDG had a nameplate rating of 30 Megawatts (MW) and consisted of two boilers. The



original CCR surface impoundment at EDG was located to the south of the generating plant. There are no known reasonably and readily available historical documents or drawings that identify the location of the original CCR surface impoundment, however, discussions with facility personnel with knowledge of historical operations at EDG confirmed the presence of a surface impoundment located south of the generating plant at the time of initial facility operations.

At the time of initial facility operations, the CCR that was produced from the burning of coal included boiler slag and fly ash. Unit 1 consisted of two wet bottom boilers. The ash from pulverized coal that was burned in the boilers would be quenched in water which produced the slag. The slag would then be sluiced from the generating plant to a surface impoundment, presumably to the CCR surface impoundment located south of the generating plant. At the time of initial operations, the fly ash that was produced was partially recovered in mechanical cyclone separators. Discussions with facility personnel with knowledge of historical operations confirmed electrostatic precipitators were eventually constructed for Unit 1, however, the timeframe for this could not be confirmed.

In 1940, a second steam electric generating unit (Unit 2) was constructed and initiated operations. Unit 2 had a nameplate rating of 30 MW. Unit 2 was owned and operated by Wisconsin Power and Light Company. Unit 2 utilized the same wet bottom boilers as Unit 1. The pulverized coal that was burned in the boilers would be quenched in water which produced the slag. The slag would then be sluiced from the generating plant to a surface impoundment, presumably to the CCR surface impoundment located south of the generating plant. At the time of initial operations, the fly ash that was produced was partially recovered in mechanical cyclone separators.

Discussions with facility personnel with knowledge of historical operations confirmed electrostatic precipitators were eventually constructed for both Unit 1 and Unit 2, however, the timeframe for this cannot be confirmed. Once the electrostatic precipitators



were constructed the fly ash produced by Unit 1 and Unit 2 would have been sluiced to the ash disposal facility until the two units were retired.

In 1951, a third steam electric generating unit (Unit 3) was constructed and initiated operations. Unit 3 had a nameplate rating of 60 MW. Similar to Unit 1 and Unit 2, Unit 3 was owned and operated by Wisconsin Power and Light Company. The burning of coal in Unit 3 produced slag and fly ash. At the time of initial operations, the slag that was produced would be sluiced from the generating plant to a surface impoundment, presumably to the CCR surface impoundment located south of the generating plant. The fly ash that was produced was not recovered.

In 1969, EDG constructed an ash disposal facility (See Appendix A). The ash disposal facility was constructed west of the generating plant and west of Lakeshore Drive. As discussed in a Groundwater Assessment Report¹ dated September 1997, the ash disposal facility was constructed by excavating native soil, which consisted mostly of silt and clay, and mounding the excavated soil to form a perimeter berm. At the time of initial construction, the ash disposal facility became a primary receiver of CCR. The initial CCR sluiced to the ash disposal facility included boiler slag from Unit 1, Unit 2, and Unit 3. The initial layout of the ash disposal facility consisted of one large CCR surface impoundment as identified in historical aerial photographs (See Appendix B). A secondary pond was constructed adjacent to the southeast side of the CCR surface impoundment for decanting effluent from the ash disposal facility. A hydraulic structure consisting of an overflow weir was constructed along the perimeter berm between the ash disposal facility and the secondary pond. Additional information regarding the historical construction and use, as well as modifications to the ash disposal facility is discussed in further detail throughout Section 3.

¹ Groundwater Assessment Report – Edgewater Closed Ash Disposal Facility, Wisconsin Power and Light Company, September 1997, RMT, Inc.



A fourth steam electric generating unit (Unit 4) was constructed and initiated operations in 1969. Unit 4 had a nameplate rating of 350 MW. Unit 4 was owned and operated by Wisconsin Power and Light Company, as well as Wisconsin Public Service Corporation. The burning of coal in Unit 4 produced both slag and fly ash, as well as air heater ash. At the time of initial operations, the slag that was produced was sluiced to the ash disposal facility. The fly ash that was produced by Unit 4 was carried as particulate matter by the flue gases into the electrostatic precipitators where it was collected. The fly ash that was collected was then sluiced to the ash disposal facility. In addition to the slag and fly ash, the air heater ash that was produced was also sluiced to the ash disposal facility.

In 1977, electrostatic precipitators were constructed for Unit 3. The fly ash that was produced by Unit 3 was carried as particulate matter by the flue gases into the electrostatic precipitators where it was collected. The fly ash that was collected was then sluiced to the ash disposal facility, along with the slag produced by Unit 3.

In 1983, Unit 1 and Unit 2 at EDG were retired. Slag that was formerly produced by the two units was no longer sluiced to the ash disposal facility.

In 1985, EDG modified CCR operations with the conversion from sluiced fly ash to a dry fly ash handling system. The conversion involved Unit 3 and Unit 4. The fly ash that was collected by the electrostatic precipitators, for both Unit 3 and Unit 4, was pneumatically conveyed to the Unit 4 fly ash storage silo as it ceased being sluiced to the ash disposal facility. Following conversion to a dry fly ash handling system, EDG initiated closure of the western portion of the ash disposal facility. As discussed in a Groundwater Assessment Report² dated September 1997, dry fly ash from Unit 3 and Unit 4 was used to bring the western portion of the ash disposal facility to final grades. A clay cap was placed on the closed ash disposal facility in 1986. The CCR surface impoundments that remained after closure of the western portion of the ash disposal

² Groundwater Assessment Report – Edgewater Closed Ash Disposal Facility, Wisconsin Power and Light Company, September 1997, RMT, Inc.



facility included a slag basin (presently the EDG Slag Pond), the north WPDES basin (presently the EDG North A-Pond), and the south WPDES basin (presently the EDG South A-Pond). With the closure of the western portion of the ash disposal facility also came the incorporation of what was identified as the primary pond in historical drawings (presently the EDG B-Pond), which was located in the southeast corner of the ash disposal facility footprint. The primary pond consisted of the facility's original overflow weir hydraulic structure that discharged into the secondary pond (presently the EDG C-Pond). Additional information regarding the modifications to the ash disposal facility are provided in further detail throughout Section 3.

In addition to the conversion to dry fly ash handling for Unit 3 and Unit 4, as well as closure of the ash disposal facility, a fifth steam electric generating unit (Unit 5) was constructed and initiated operations in 1985. Unit 5 has a nameplate rating of 385 MW. At the time of initial operation, the owners and operators of Unit 5 included Wisconsin Power and Light Company, as well as Wisconsin Electric. The burning of coal in Unit 5 produces bottom ash, fly ash, and economizer ash. At the time of initial operation, the bottom ash was collected in the hydrobins, while the excess process water was sent to the surge tank. Water in the surge tank included excess process water from the Unit 5 hydrobin, steam water treatment reject water, and water from the facility floor drains, which was pumped to the north and south WPDES Basins (presently identified as the EDG North A-Pond and EDG South A-Pond). The bottom ash was dredged as needed and stockpiled adjacent to the CCR surface impoundments for dewatering prior to transporting off-site for beneficial reuse. The fly ash that was produced by Unit 5 was carried as particulate matter by the flue gases into the electrostatic precipitators where it was collected. The fly ash that was collected was then pneumatically conveyed to the Unit 5 fly ash storage silo. The fly ash within the storage silo would then be loaded into over-the-road haul trucks and transported off-site for either beneficial reuse or disposal at the EDG I-43 landfill, located off-site. The economizer ash was collected in an economizer hopper. The economizer ash would then be conveyed to the Unit 4 fly ash



storage silo where it would then be loaded into over-the-road haul trucks and transported off-site for disposal at the EDG I-43 landfill.

Discussions with facility personnel with knowledge of historical operations confirmed that in 2005, EDG added on an economizer hopper to Unit 4. With the addition of the economizer hopper, the economizer ash that was produced was collected and conveyed to the Unit 4 fly ash storage silo along with the fly ash from Unit 3 and Unit 4 and the economizer ash from Unit 5.

In 2015, Unit 3 was retired. As a result, slag and fly ash was no longer produced by the unit. As EDG exists today, the generating plant consists of two steam electric generating units (Unit 4 and Unit 5). Unit 4 remains owned by both Wisconsin Power and Light Company, as well as Wisconsin Public Service Corporation. Unit 5 is solely owned by Wisconsin Power and Light Company. Sub-bituminous coal is the primary fuel for producing steam. The burning of coal at EDG produces various forms of CCR, which includes slag (Unit 4 only), bottom ash (Unit 5 only), economizer ash, and fly ash. CCR operations at EDG include Unit 4 slag being sluiced to what is now identified as the EDG Slag Pond. The slag is dredged from the EDG Slag Pond on a regular basis and temporarily stockpiled in a containerized area adjacent to the existing CCR surface impoundments for dewatering prior to transporting off-site via over-the-road haul trucks for beneficial reuse. The Unit 5 bottom ash produced at EDG is collected in a hydrobin at the generating plant. Bottom ash from the hydrobin is dewatered and transported via over-the-road haul trucks to the area west of the EDG South A-Pond for temporary staging in a contained, clay-lined area prior to transporting off-site for beneficial reuse. The economizer ash produced by Unit 4 is collected in a hopper and conveyed to the Unit 4 fly ash storage silo. Similarly, the economizer ash produced by Unit 5 is collected in a hopper and conveyed to the Unit 4 fly ash storage silo. The Unit 4 fly ash, as well as economizer ash from Unit 4 and Unit 5, is loaded into over-the-road haul trucks or rail cars for transportation off-site to EDGs I-43 landfill for disposal. The Unit 5 fly ash that is collected in the Unit 5 fly ash storage silo is loaded into over-the-road haul trucks or



rail cars and transported off-site for either beneficial reuse or disposal at the EDG I-43 landfill. Additional discussions regarding the purpose of each of the existing CCR surface impoundments at EDG is provided in further detail throughout Section 3.



3 HISTORY OF CONSTRUCTION - §257.73(c)(1)

This Report documents the history of construction information for the existing CCR surface impoundments to the extent feasible, provided that such information is reasonable and readily available. The following activities were completed in order to reasonably collect and assemble the readily available history of construction information:

- File review at the local regulatory agency;
- Historical aerial photography review;
- Historical topography review;
- Onsite design drawing, specification, and report review;
- Electronic design drawing, specification, and report review; and
- Interview(s) with onsite personnel with historical knowledge of the existing CCR surface impoundment.

3.1 EDG Slag Pond

The following subsections are intended to meet the requirements of the CCR Rule §257.73(c)(1) for the EDG Slag Pond.

3.1.1 CCR Unit Location - §257.73(c)(1)(ii)

The EDG Slag Pond is located southwest of the generating plant, north of the EDG North A-Pond, and adjacent to the closed ash disposal facility. The location of the EDG Slag Pond, in reference to the surrounding topography, is identified on both a USGS 7 ½ minute topographic quadrangle map and aerial photograph on Figure 1. The location of the EDG Slag Pond, in reference to the immediate surroundings within the EDG property, is identified on Figure 2.

3.1.2 Statement of Purpose - §257.73(c)(1)(iii)

The EDG Slag Pond receives influent flow from the generating plant via the Unit 4 boiler slag tanks. The water-slag slurry discharges into the southwest portion of the EDG Slag Pond. The slag is dredged out of the EDG Slag Pond and stockpiled adjacent to the existing CCR surface impoundment for dewatering. The slag is then screened to separate the coarsely graded material from the finely graded material prior to being transported off-site for beneficial reuse.



The water in the EDG Slag Pond flows to the southwest where it gravity flows through a v-notch weir and through a four feet wide concrete structure into a 48-inch diameter corrugated metal pipe (CMP). The water from the EDG Slag Pond, which combines with flows from the EDG North A-Pond and EDG South A-Pond in the 48-inch diameter CMP, flows to the south into the northwest corner of the EDG B-Pond. The water in the EDG B-Pond flows to the east through an overflow weir structure, which is also the original hydraulic structure associated with the initial ash disposal facility. CCR that does not settle in the EDG Slag Pond or EDG A-Ponds settles in the EDG B-Pond. As determined by WPL, process water discharging from the EDG B-Pond does not contain a significant quantity of CCR, and downstream impoundments contain only de minimis quantities of CCR. The water gravity flows to the east through a 24-inch diameter CMP where it discharges into the west side of the EDG C-Pond. The water in the EDG C-Pond gravity flows a significant length to the east through two CMPs. The northeast corner of the EDG C-Pond consists of a 20-inch diameter CMP while the southeast corner of the EDG C-Pond consists of a 24-inch diameter CMP. The two CMPs tie in together prior to discharging into the EDG F-Pond which is located south of the generating plant. The EDG F-Pond also receives influent flows from the EDG E-Pond. The EDG E-Pond, located south of the EDG F-Pond, collects storm water runoff from the coal pile storage area. The water that accumulates in the EDG F-Pond flows to the east through the facility's Wisconsin Pollution Discharge Elimination System (WPDES) Outfall 004 and discharges into Lake Michigan.

3.1.3 Physical Layout Information - §257.73(c)(1)(iv)

As identified in an Inflow Flood Control Plan³ prepared for EDG in accordance with §257.82 of the CCR Rule, the EDG Slag Pond has a watershed of approximately 2.9 acres. The drainage area includes the surface area of the EDG Slag Pond, as well as a portion of the slag dewatering area located to the west of the EDG Slag Pond.

³ Inflow Flood Control Plan, Edgewater Generating Station, 2016, Hard Hat Environmental Services



As discussed in an Annual Inspection Report⁴ prepared for EDG in accordance with §257.83 of the CCR Rule, the EDG Slag Pond is incised along the west side of the CCR Unit. The southern embankment of the EDG Slag Pond separates the CCR surface impoundment from the EDG North A-Pond. The east embankment of the EDG Slag Pond has a height of approximately 12 feet from the crest to the toe of the downstream slope of the embankment at its greatest height. The interior storage depth of the EDG Slag Pond is approximately 17 feet. Currently, the total volume of impounded CCR and water within the EDG Slag Pond is approximately 47,000 cubic yards.

3.1.4 Foundation and Abutment Properties - §257.73(c)(1)(v)

As discussed in a Groundwater Assessment Report⁵, dated September 1997, the unconsolidated materials in the site primarily consist of glacial till with some lacustrine and alluvial deposits. Based on site boring logs, local private well logs, and geologic cross sections, the glacial sediment is predominately silt and clay with some sand intervals. The glacial deposits are underlain by the Silurian dolomite in most areas, although a small thickness of the Devonian Milwaukee Formation (mostly dolomite) may overlie the Silurian in some areas. The bedrock, which is encountered at depths ranging from 75 to 140 feet below ground surface, generally slopes to the south in the vicinity of the site.

As identified in a Safety Factor Assessment⁶ prepared for EDG in accordance with §257.73(e) of the CCR Rule, the embankments foundation consist of medium dense to very loose silt starting at elevation 586 feet and extending to a medium stiff clay at an elevation of 560 to 569 feet.

3.1.5 Historical Construction and Use - §257.73(c)(1)(vi)

The EDG Slag Pond (formerly identified as the northeastern part of the ash disposal facility in historical drawings) was constructed in 1969 in an area located west of the generating plant, west of Lakeshore Drive. After review of readily available information

⁴ Annual Inspection Report, Edgewater Generating Station, 2016, Hard Hat Environmental Services

⁵ Groundwater Assessment Report – Edgewater Closed Ash Disposal Facility, Wisconsin Power and Light Company, September 1997, RMT, Inc.

⁶ Safety Factor Assessment, Edgewater Generating Station, 2016, Hard Hat Environmental Services
Wisconsin Power and Light Company – Edgewater Generating Station



there were no known historical drawings that identify the initial layout of the ash disposal area or the initial layout of the EDG Slag Pond.

The only known readily available document that detailed the method of site preparation and construction of the ash disposal facility was in a Groundwater Assessment Report prepared by RMT, Inc. The report states the unlined closed ash disposal facility was constructed by excavating native soil, which consisted mostly of silt and clay, and mounding the excavated soil to form a perimeter berm. In addition to the Groundwater Assessment Report, historical drawings from 1976 (See Appendix A) identify the existing topography and layout of the ash disposal area prior to construction of the EDG Slag Pond.

At the time of initial construction, the ash disposal facility became the primary receiver of CCR. The initial CCR sluiced to the ash disposal facility included boiler slag from Unit 1, Unit 2, and Unit 3. As identified in historical drawings (See Appendix A) and historical aerial photographs (See Appendix B), the layout of the ash disposal facility consisted of one large CCR surface impoundment. A secondary pond was constructed adjacent to the southeast side of the CCR surface impoundment for decanting effluent from the ash disposal facility. The initial hydraulic structure associated with the ash disposal facility consisted of an overflow weir that was constructed along the perimeter berm between the ash disposal facility and the secondary pond.

In addition to slag from Unit 1, Unit 2, and Unit 3 being sluiced to the ash disposal facility, CCR from Unit 4 was sluiced to the ash disposal facility with its initial operation in 1969. The CCR produced from Unit 4 included both slag and fly ash, as well as air heater ash. The slag that was produced was sluiced from the boiler furnace to the ash disposal facility. The fly ash that was produced by Unit 4 was carried as particulate matter by the flue gases into the electrostatic precipitators where it was electrostatically precipitated and collected. The fly ash that was collected was then sluiced to the ash disposal facility. The air heater ash that was produced was also sluiced to the ash disposal facility.



In 1977, an electrostatic precipitator was constructed for Unit 3. The fly ash that was produced by Unit 3 was carried as particulate matter by the flue gases into the electrostatic precipitators where it was electrostatically precipitated and collected. The fly ash that was collected was then sluiced to the ash disposal facility, along with the slag produced by Unit 3.

A historical aerial photograph from 1978 (See Appendix B) identifies the first known modifications to the ash disposal facility with the construction of the EDG North A-Pond (formerly identified as North WPDES Basin in historical drawings) and EDG South A-Pond (formerly identified as South WPDES Basin in historical drawings). From the historical aerial photographs (See Appendix B), the existing footprint of the EDG Slag Pond doesn't exist in its present layout until 1987. At some point between 1981 and 1987 the current layout of the EDG Slag Pond was constructed, however, the exact timeframe for this modification cannot be confirmed.

In 1983, Unit 1 and Unit 2 at EDG were retired. Slag that was formerly produced by the two units was no longer sluiced to the ash disposal facility. The fly ash produced by Unit 1 and Unit 2 originally was partially recovered by the mechanical cyclone separators, while the remaining portion was carried out as particulate matter from the boiler furnaces and emitted as part of the flue gas. Discussions with facility personnel with knowledge of historical operations confirmed electrostatic precipitators were eventually constructed for both Unit 1 and Unit 2, however, the timeframe for this modification cannot be confirmed. Once the electrostatic precipitators were constructed, the fly ash produced by Unit 1 and Unit 2 would have been sluiced to the ash disposal facility until the two units were retired.

In 1985, EDG modified CCR operations with the conversion from sluiced fly ash to a dry fly ash handling system. The conversion involved Unit 3 and Unit 4. The fly ash that was collected by the electrostatic precipitators, for both Unit 3 and Unit 4, was pneumatically conveyed to the Unit 4 fly ash storage silo as it ceased being sluiced to the



ash disposal facility. Following conversion to a dry fly ash handling system, EDG initiated closure of the western portion of the ash disposal facility. As discussed in a Groundwater Assessment Report⁷ dated September 1997, dry fly ash from Unit 3 and Unit 4 was used to bring the western portion of the ash disposal facility to final grades. A clay cap was placed on the closed ash disposal facility in 1986. The CCR surface impoundments that remained after closure of the western portion of the ash disposal facility included the EDG Slag Pond (formerly identified as the slag basin in historical drawings), the EDG North A-Pond (formerly identified as the north WPDES basin), and the EDG South A-Pond (formerly identified as the south WPDES basin). With the closure of the western portion of the ash disposal facility also came the incorporation of the EDG B-Pond (formerly identified as the primary pond in historical drawings), which is located in the southeast corner of the initial ash disposal facility. The EDG B-Pond consists of the facility's original hydraulic structure that discharges into the EDG C-Pond (formerly identified as the secondary pond in historical drawings).

In-situ soil properties of the EDG Slag Pond were identified in a Safety Factor Assessment. As discussed in the Safety Factor Assessment, soil borings were installed in 2010 (See Appendix D). The soil boring data observed the embankments of the EDG Slag Pond to be constructed of very stiff to stiff compacted clay (CL).

The following list provides a general overview of known modifications associated with the EDG Slag Pond since construction of the initial ash disposal facility.

- The existing hydraulic structure associated with the EDG Slag Pond was installed. The existing hydraulic structure consists of a four feet wide concrete structure with a v-notch weir. Water within the EDG Slag Pond flows through the v-notch weir and through the concrete structure into a 48-inch diameter CMP. The timeframe of this modification has not been documented.

⁷ Groundwater Assessment Report – Edgewater Closed Ash Disposal Facility, Wisconsin Power and Light Company, September 1997, RMT, Inc.
Wisconsin Power and Light Company – Edgewater Generating Station
History of Construction
September 21, 2016



- The 48-inch diameter CMP that connects the EDG Slag Pond to the EDG B-Pond was installed. The 48-inch diameter CMP includes influent flows from the EDG Slag Pond, EDG North A-Pond, and EDG South A-Pond. The timeframe of this modification has not been documented.
- In 2015, Unit 3 at EDG was retired. As a result, slag was no longer sluiced to the EDG Slag Pond from Unit 3.

Historical aerial photographs (See Appendix B) and historical topographic maps (See Appendix C) identify the topographic changes to the EDG Slag Pond that have occurred since the time of initial facility operations.

3.1.6 Structures, Appurtenances, and Operations- §257.73(c)(1)(vii)

Detailed dimensional drawings of the EDG Slag Pond that were reasonably and readily available are identified below. The detailed dimensional drawings were obtained from various designs, plans, and reports that were assembled during the historical information review.

- Edgewater Ash Disposal Site (1976) – Drawings prepared by Donohue & Associates, Inc. provides existing topography and layout of the ash disposal facility, as well as proposed site development plans and cross-sections (Appendix A).
- Edgewater Closed Ash Disposal Facility (1991) – Drawings prepared by Dames & Moore provides layout and cross-sections of the modifications to the ash disposal facility after closure, inclusive of the EDG Slag Pond (slag basin), EDG North A-Pond (North WPDES Basin), EDG South A-Pond (South WPDES Basin), EDG B-Pond (Primary Pond), and EDG C-Pond (Secondary Pond). Drawings also provide water table and aquifer mapping (Appendix E).



- Edgewater Generating Station Ash Pond Evaluation (2011) – Drawings prepared by Miller Engineers Scientists provides topographic layout and cross-sections of the EDG Slag Pond (Appendix E).

3.1.7 Instrumentation - §257.73(c)(1)(viii)

The EDG Slag Pond does not have existing instrumentation that supports the operation of the CCR Unit. Additionally, review of readily available historical documents has not identified instrumentation that was used to support the operation of the EDG Slag Pond.

3.1.8 Area-Capacity Curve - §257.73(c)(1)(ix)

An area-capacity curve identifies the relationship between the surface area of the existing CCR surface impoundment and an elevation, which corresponds to an available storage capacity. After review of readily available historical documents there is no readily available information regarding area-capacity curves for the EDG Slag Pond.

3.1.9 Spillway and Diversion Features - §257.73(c)(1)(x)

Water within the EDG Slag Pond flows to the southwest where it gravity flows through a v-notch weir and through a four feet wide concrete structure into a 48-inch diameter CMP. The hydraulic structure is constructed of non-erodible material and designed to carry sustained flows. Additional information regarding the hydraulic capacity of the hydraulic structure associated with the EDG Slag Pond is provided in the Inflow Flood Control Plan⁸.

3.1.10 Construction Specifications, Surveillance, Maintenance, and Repair - §257.73(c)(1)(xi)

EDG implements a Site-Specific Inspection and Maintenance (I&M) Plan⁹, in accordance with an Alliant Energy I&M Plan¹⁰. The Site-Specific I&M Plan has been implemented at EDG in order to identify the factors which may affect the long-term stability of the existing CCR surface impoundment. The Site-Specific I&M Plan identifies existing operation and maintenance activities, and identifies the inspection, monitoring,

⁸ Inflow Flood Control Plan, Edgewater Generating Station, 2016, Hard Hat Environmental Services

⁹ Inspection and Maintenance (I&M) Plan, Edgewater Generating Station, October 2015, Version 2.0-Revision 0.0

¹⁰ Inspection and Maintenance (I&M) Plan, Alliant Energy, September 2015, Version 2.0-Revision 0.0

Wisconsin Power and Light Company – Edgewater Generating Station

History of Construction
September 21, 2016



maintenance, and recordkeeping requirements as outlined in the Alliant Energy I&M Plan in order to maintain the integrity of the existing CCR surface impoundment.

Visual inspections of the EDG Slag Pond are completed in accordance with §257.83 of the CCR Rule. At intervals not exceeding seven days, the EDG Slag Pond is visually inspected for any appearances of structural weakness or other conditions which are disrupting or have the potential to disrupt the operation or safety of the existing CCR surface impoundment. In addition to seven-day inspections, EDG conducts event-related inspections which may include inspections following storm events, seismic events, major maintenance activities, as well as other unusual events. Annual inspections are conducted by a qualified PE who is familiar with the requirements of the CCR Rule, the Alliant Energy I&M Plan, the EDG Site-Specific I&M Plan, and other facility specific information pertaining to the existing CCR surface impoundment.

Maintenance activities that are completed at EDG may include routine maintenance, event-related maintenance, and long-term maintenance. Routine maintenance activities may include management of vegetation (or other forms of slope protection), tree and sapling removal, reseeding of disturbed vegetated areas, removal of debris from collection and diversion channels, and repair of eroded areas. Event-related maintenance activities may include maintenance after unusual events such as heavy rainfall, periods of very high winds, or seismic activity. Maintenance may include repair of eroded areas or removal of damaged vegetation. Long-term maintenance activities are identified as part of the ongoing inspection program, through the annual inspections, or through other engineering evaluations and may include larger remediation activities.

3.1.11 Structural Instability Records - §257.73(c)(1)(xii)

After review of readily available historical documents there are no known records of structural instability associated with the EDG Slag Pond that were identified.

3.2 EDG North A-Pond



The following subsections are intended to meet the requirements of the CCR Rule §257.73(c)(1) for the EDG North A-Pond.

3.2.1 CCR Unit Location - §257.73(c)(1)(ii)

The EDG North A-Pond is located southwest of the generating plant and south of the EDG Slag Pond. The location of the EDG North A-Pond, in reference to the surrounding topography, is identified on both a USGS 7 ½ minute topographic quadrangle map and aerial photograph on Figure 1. The location of the EDG North A-Pond, in reference to the immediate surroundings within the EDG property, is identified on Figure 2.

3.2.2 Statement of Purpose - §257.73(c)(1)(iii)

The EDG North A-Pond as it currently exists is generally operated as a storm water detention pond with the only influent sources consisting of precipitation and storm water runoff from the surrounding area. The EDG North A-Pond is no longer a primary receiver of the surge tank process flows from the generating plant. The hydraulic structure associated with the EDG North A-Pond consists of an 18-inch diameter corrugated plastic pipe (CPP) located in the southwest corner of the existing CCR surface impoundment. The hydraulic structure is currently plugged and therefore the EDG North A-Pond does not discharge. The water that presently collects within the EDG North A-Pond either exfiltrates through the bottom of the CCR surface impoundment or evaporates.

3.2.3 Physical Layout Information - §257.73(c)(1)(iv)

As identified in an Inflow Flood Control Plan¹¹ prepared for EDG in accordance with §257.82 of the CCR Rule, the EDG North A-Pond has a watershed of approximately 2.7 acres. The drainage area includes the surface area of the EDG North A-Pond, as well as a portion of the slag dewatering area located to the west of the EDG North A-Pond.

As discussed in an Annual Inspection Report¹² prepared for EDG in accordance with §257.83 of the CCR Rule, the EDG North A-Pond is incised along the west side of the CCR

¹¹ Inflow Flood Control Plan, Edgewater Generating Station, 2016, Hard Hat Environmental Services

¹² Annual Inspection Report, Edgewater Generating Station, 2016, Hard Hat Environmental Services

Wisconsin Power and Light Company – Edgewater Generating Station

History of Construction

September 21, 2016



Unit. The northern embankment of the EDG North A-Pond separates the CCR surface impoundment from the EDG Slag Pond. The southern embankment separates the CCR surface impoundment from the EDG South A-Pond. The east embankment of the EDG North A-Pond has a height of approximately 18 feet from the crest to the toe of the downstream slope of the embankment at its greatest height. The interior storage depth of the EDG North A-Pond is approximately 21 feet. Currently, the total volume of impounded CCR and water within the EDG North A-Pond is approximately 73,000 cubic yards.

3.2.4 Foundation and Abutment Properties - §257.73(c)(1)(v)

As discussed in a Groundwater Assessment Report¹³, dated September 1997, the unconsolidated materials in the site primarily consist of glacial till with some lacustrine and alluvial deposits. Based on site boring logs, local private well logs, and geologic cross sections, the glacial sediment is predominately silt and clay with some sand intervals. The glacial deposits are underlain by the Silurian dolomite in most areas, although a small thickness of the Devonian Milwaukee Formation (mostly dolomite) may overlie the Silurian in some areas. The bedrock, which is encountered at depths ranging from 75 to 140 feet below ground surface, generally slopes to the south in the vicinity of the site.

As identified in a Safety Factor Assessment¹⁴ prepared for EDG in accordance with §257.73(e) of the CCR Rule, the embankments foundation consist of medium dense to very loose silt starting at elevation 586 feet and extending to a medium stiff clay at an elevation of 560 to 569 feet.

3.2.5 Historical Construction and Use - §257.73(c)(1)(vi)

The EDG North A-Pond (formerly identified as a portion of the eastern part of the ash disposal facility in historical drawings) was constructed in 1969 in an area located west of the generating plant, west of Lakeshore Drive. After review of readily available

¹³ Groundwater Assessment Report – Edgewater Closed Ash Disposal Facility, Wisconsin Power and Light Company, September 1997, RMT, Inc.

¹⁴ Safety Factor Assessment, Edgewater Generating Station, 2016, Hard Hat Environmental Services
Wisconsin Power and Light Company – Edgewater Generating Station
History of Construction
September 21, 2016



information there were no known historical drawings that identify the initial layout of the ash disposal area or the initial layout of the EDG North A-Pond.

The only known readily available document that detailed the method of site preparation and construction of the ash disposal facility was in a Groundwater Assessment Report¹⁵ dated September 1997. The report states the unlined closed ash disposal facility was constructed by excavating native soil, which consisted mostly of silt and clay, and mounding the excavated soil to form a perimeter berm. In addition to the Groundwater Assessment Report, historical drawings from 1976 (See Appendix A) identify the existing topography and layout of the ash disposal area prior to construction of the EDG North A-Pond.

At the time of initial construction, the ash disposal facility became the primary receiver of CCR. The initial CCR sluiced to the ash disposal facility included boiler slag from Unit 1, Unit 2, and Unit 3. As identified in historical drawings (See Appendix A) and historical aerial photographs (See Appendix B), the layout of the ash disposal facility consisted of one large CCR surface impoundment. A secondary pond was constructed adjacent to the southeast side of the CCR surface impoundment for decanting effluent from the ash disposal facility. The initial hydraulic structure associated with the ash disposal facility consisted of an overflow weir that was constructed along the perimeter berm between the ash disposal facility and the secondary pond.

In addition to slag from Unit 1, Unit 2, and Unit 3 being sluiced to the ash disposal facility, CCR from Unit 4 was sluiced to the ash disposal facility with its initial operation in 1969. The CCR produced from Unit 4 included both slag and fly ash, as well as air heater ash. The slag that was produced was sluiced from the boiler furnace to the ash disposal facility. The fly ash that was produced by Unit 4 was carried as particulate matter by the flue gases into the electrostatic precipitators where it was electrostatically precipitated

¹⁵ Groundwater Assessment Report – Edgewater Closed Ash Disposal Facility, Wisconsin Power and Light Company, September 1997, RMT, Inc.
Wisconsin Power and Light Company – Edgewater Generating Station
History of Construction
September 21, 2016



and collected. The fly ash that was collected was then sluiced to the ash disposal facility. The air heater ash that was produced was also sluiced to the ash disposal facility.

In 1977, electrostatic precipitators were constructed for Unit 3. The fly ash that was produced by Unit 3 was carried as particulate matter by the flue gases into the electrostatic precipitators where it was electrostatically precipitated and collected. The fly ash that was collected was then sluiced to the ash disposal facility, along with the slag produced by Unit 3.

A historical aerial photograph from 1978 (See Appendix B) identifies the first known modifications to the ash disposal facility with the construction of the EDG North A-Pond (formerly identified as North WPDES Basin in historical drawings) and EDG South A-Pond (formerly identified as South WPDES Basin in historical drawings). At some point between 1969 and 1978 the current layout of the EDG North A-Pond was constructed, however, the exact timeframe for this cannot be confirmed.

In 1983, Unit 1 and Unit 2 at EDG were retired. Slag that was formerly produced by the two units was no longer sluiced to the ash disposal facility. The fly ash produced by Unit 1 and Unit 2 originally was partially recovered by the mechanical cyclone separators, while the remaining portion would get carried as particulate matter from the boiler furnaces and emitted as part of the flue gas. Discussions with facility personnel with knowledge of historical operations confirmed electrostatic precipitators were eventually constructed for both Unit 1 and Unit 2, however, the timeframe for this cannot be confirmed. Once the electrostatic precipitators were constructed the fly ash produced by Unit 1 and Unit 2 would have been sluiced to the ash disposal facility until the two units were retired.

In 1985, EDG modified CCR operations with the conversion from sluiced fly ash to a dry fly ash handling system. The conversion involved Unit 3 and Unit 4. The fly ash that was collected by the electrostatic precipitators, for both Unit 3 and Unit 4, was



pneumatically conveyed to the Unit 4 fly ash storage silo as it ceased being sluiced to the ash disposal facility. Following conversion to a dry fly ash handling system, EDG initiated closure of the western portion of the ash disposal facility. As discussed in a Groundwater Assessment Report¹⁶ dated September 1997, dry fly ash from Unit 3 and Unit 4 was used to bring the western portion of the ash disposal facility to final grades. A clay cap was placed on the closed ash disposal facility in 1986. The CCR surface impoundments that remained after closure of the western portion of the ash disposal facility included the EDG Slag Pond (formerly identified as the slag basin in historical drawings), the EDG North A-Pond (formerly identified as the north WPDES basin), and the EDG South A-Pond (formerly identified as the south WPDES basin). With the closure of the western portion of the ash disposal facility also came the incorporation of the EDG B-Pond (formerly identified as the primary pond in historical drawings), which is located in the southeast corner of the initial ash disposal facility. The EDG B-Pond consists of the facility's original hydraulic structure that discharges into the EDG C-Pond (formerly identified as the secondary pond in historical drawings).

In-situ soil properties of the EDG North A-Pond were identified in a Safety Factor Assessment prepared for EDG in accordance with §257.73(e) of the CCR Rule. As discussed in the Safety Factor Assessment, soil borings were installed in 2010 (Appendix D). The soil boring data observed the embankments of the North A-Pond to be constructed of very stiff to stiff compacted clay (CL).

The following list provides a general overview of known modifications associated with the EDG North A-Pond since construction of the initial ash disposal facility.

- The existing hydraulic structure associated with the EDG North A-Pond was installed. The existing hydraulic structure consists of an 18-inch diameter CPP. Water within the EDG North A-Pond flowed through the hydraulic structure into

¹⁶ Groundwater Assessment Report – Edgewater Closed Ash Disposal Facility, Wisconsin Power and Light Company, September 1997, RMT, Inc.
Wisconsin Power and Light Company – Edgewater Generating Station
History of Construction
September 21, 2016



a concrete sluice box. The water within the sluice box flowed through a Parshall flume structure and into the 48-inch diameter CMP that connects the EDG Slag Pond to the EDG B-Pond. The timeframe of this modification has not been documented.

- The instrumentation associated with the EDG North A-Pond, as well as the EDG South A-Pond, includes a Parshall flume structure and flow monitoring equipment. The Parshall flume and flow monitoring equipment were installed southwest of the EDG North A-Pond. The timeframe of this modification has not been documented.
- The 48-inch diameter CMP that connects the EDG Slag Pond to the EDG B-Pond was installed. The 48-inch diameter CMP includes influent flows from the EDG Slag Pond, EDG North A-Pond, and EDG South A-Pond. The timeframe of this modification has not been documented.
- The EDG North A-Pond ceased being a primary receiver of Unit 5 bottom ash, as well as other process flows from the generating plant. The timeframe of this modification has not been documented.

Historical aerial photographs (See Appendix B) and historical topographic maps (See Appendix C) identify the topographic changes to the EDG North A-Pond that have occurred since the time of initial facility operations.

3.2.6 Structures, Appurtenances, and Operations- §257.73(c)(1)(vii)

Detailed dimensional drawings of the EDG North A-Pond that were reasonably and readily available are identified below. The detailed dimensional drawings were obtained from various designs, plans, and reports that were assembled during the historical information review.

- Edgewater Ash Disposal Site (1976) – Drawings prepared by Donohue & Associates, Inc. provides existing topography and layout of the ash disposal



facility, as well as proposed site development plans and cross-sections (Appendix A).

- Edgewater Closed Ash Disposal Facility (1991) – Drawings prepared by Dames & Moore provides layout and cross-sections of the modifications to the ash disposal facility after closure, inclusive of the EDG Slag Pond (slag basin), EDG North A-Pond (North WPDES Basin), EDG South A-Pond (South WPDES Basin), EDG B-Pond (Primary Pond), and EDG C-Pond (Secondary Pond). Drawings also provide water table and aquifer mapping (Appendix E).
- Edgewater Generating Station Ash Pond Evaluation (2011) – Drawings prepared by Miller Engineers Scientists provides topographic layout and cross-sections of the EDG North A-Pond (Appendix E).

3.2.7 Instrumentation - §257.73(c)(1)(viii)

Instrumentation used to support the operation of the EDG North A-Pond consists of a Parshall flume discharge structure and equipment to measure the flow of the combined discharged water of the EDG North A-Pond and EDG South A-Pond. The instrumentation is located near the southwest corner of the EDG North A-Pond.

3.2.8 Area-Capacity Curve - §257.73(c)(1)(ix)

An area-capacity curve identifies the relationship between the surface area of the existing CCR surface impoundment and an elevation, which corresponds to an available storage capacity. After review of readily available historical documents there is no readily available information regarding area-capacity curves for the EDG North A-Pond.

3.2.9 Spillway and Diversion Features - §257.73(c)(1)(x)

The EDG North A-Pond generally operates as a zero discharge pond. However, water within the EDG North A-Pond has the ability to flow to the southwest corner of the existing CCR surface impoundment where it would flow through an 18-inch diameter CPP. The hydraulic structure is constructed of non-erodible material and designed to carry sustained flows. Additional information regarding the hydraulic capacity of the



hydraulic structure associated with the EDG North A-Pond is provided in the Inflow Flood Control Plan¹⁷.

3.2.10 Construction Specifications, Surveillance, Maintenance, and Repair - §257.73(c)(1)(xi)

EDG implements a Site-Specific Inspection and Maintenance (I&M) Plan¹⁸, in accordance with an Alliant Energy I&M Plan¹⁹. The Site-Specific I&M Plan has been implemented at EDG in order to identify the factors which may affect the long-term stability of the existing CCR surface impoundment. The Site-Specific I&M Plan identifies existing operation and maintenance activities, and identifies the inspection, monitoring, maintenance, and recordkeeping requirements as outlined in the Alliant Energy I&M Plan in order to maintain the integrity of the existing CCR surface impoundment.

Visual inspections of the EDG North A-Pond are completed in accordance with §257.83 of the CCR Rule. At intervals not exceeding seven days, the EDG North A-Pond is visually inspected for any appearances of structural weakness or other conditions which are disrupting or have the potential to disrupt the operation or safety of the existing CCR surface impoundment. In addition to seven-day inspections, EDG conducts 30-day instrumentation inspections and event-related inspections, which may include inspections following storm events, seismic events, major maintenance activities, as well as other unusual events. Annual inspections are conducted by a qualified PE who is familiar with the requirements of the CCR Rule, the Alliant Energy I&M Plan, the EDG Site-Specific I&M Plan, and other facility specific information pertaining to the existing CCR surface impoundment.

Maintenance activities that are completed at EDG may include routine maintenance, event-related maintenance, and long-term maintenance. Routine maintenance activities may include management of vegetation (or other forms of slope protection), tree and

¹⁷ Inflow Flood Control Plan, Edgewater Generating Station, 2016, Hard Hat Environmental Services

¹⁸ Inspection and Maintenance (I&M) Plan, Edgewater Generating Station, October 2015, Version 2.0-Revision 0.0

¹⁹ Inspection and Maintenance (I&M) Plan, Alliant Energy, September 2015, Version 2.0-Revision 0.0

Wisconsin Power and Light Company – Edgewater Generating Station



sapling removal, reseeding of disturbed vegetated areas, removal of debris from collection and diversion channels, and repair of eroded areas. Event-related maintenance activities may include maintenance after unusual events such as heavy rainfall, periods of very high winds, or seismic activity. Maintenance may include repair of eroded areas or removal of damaged vegetation. Long-term maintenance activities are identified as part of the ongoing inspection program, through the annual inspections, or through other engineering evaluations and may include larger remediation activities.

3.2.11 Structural Instability Records - §257.73(c)(1)(xii)

After review of readily available historical documents there are no known records of structural instability associated with the EDG North A-Pond that were identified.

3.3 EDG South A-Pond

The following subsections are intended to meet the requirements of the CCR Rule §257.73(c)(1) for the EDG South A-Pond.

3.3.1 CCR Unit Location - §257.73(c)(1)(ii)

The EDG South A-Pond is located southwest of the generating plant, south of the EDG North A-Pond, and north of the EDG B-Pond. The location of the EDG South A-Pond, in reference to the surrounding topography, is identified on both a USGS 7 ½ minute topographic quadrangle map and aerial photograph on Figure 1. The location of the EDG South A-Pond, in reference to the immediate surroundings within the EDG property, is identified on Figure 2.

3.3.2 Statement of Purpose - §257.73(c)(1)(iii)

The EDG South A-Pond, as currently configured, is the primary receiver of water that is pumped from a surge tank. Water in the surge tank includes excess process water from the Unit 5 bottom ash hydrobin, steam water treatment reject water, and water from the facility floor drains.

The water from the surge tank is pumped to the EDG South A-Pond via a 10-inch diameter steel pipe. The water within the EDG South A-Pond flows to the west. The



hydraulic structure associated with the EDG South A-Pond consists of an 18-inch diameter CPP located in the northwest corner of the existing CCR surface impoundment. The water flows through the CPP to the west into a concrete sluice box. The water within the sluice box flows through a Parshall flume prior to discharging into a 48-inch diameter CMP. The 48-inch diameter CMP also hydraulically conveys water from the EDG Slag Pond prior to gravity flowing to the south into the northwest corner of the EDG B-Pond. The water in the EDG B-Pond flows to the east through an overflow weir structure, which is also the original hydraulic structure associated with the initial ash disposal facility. CCR that does not settle in the EDG Slag Pond or EDG A-Ponds settles in the EDG B-Pond. As determined by WPL, process water discharging from the EDG B-Pond does not contain a significant quantity of CCR, and downstream impoundments contain only de minimis quantities of CCR. The water gravity flows to the east through a 24-inch diameter CMP where it discharges into the west side of the EDG C-Pond. The water in the EDG C-Pond gravity flows approximately 1,600 feet to the east through two CMPs. The northeast corner of the EDG C-Pond consists of a 20-inch diameter CMP while the southeast corner of the EDG C-Pond consists of a 24-inch diameter CMP. The two CMPs tie in together prior to discharging into the EDG F-Pond which is located south of the generating plant. The EDG F-Pond also receives influent flows from the EDG E-Pond. The EDG E-Pond, located south of the EDG F-Pond, collects storm water runoff from the coal pile storage area. The water that accumulates in the EDG F-Pond flows to the east through the facility's Wisconsin Pollution Discharge Elimination System (WPDES) Outfall 004 and discharges into Lake Michigan.

3.3.3 Physical Layout Information - §257.73(c)(1)(iv)

As identified in an Inflow Flood Control Plan²⁰ prepared for EDG in accordance with §257.82 of the CCR Rule, the EDG South A-Pond has a watershed of approximately 3.7 acres. The drainage area includes the surface area of the EDG South A-Pond, as well as a portion of the bottom ash staging area located to the west of the EDG South A-Pond.

²⁰ Inflow Flood Control Plan, Edgewater Generating Station, 2016, Hard Hat Environmental Services
Wisconsin Power and Light Company – Edgewater Generating Station
History of Construction
September 21, 2016



As discussed in an Annual Inspection Report²¹ prepared for EDG in accordance with §257.83 of the CCR Rule, the EDG South A-Pond is incised along the west side of the CCR Unit. The northern embankment of the EDG South A-Pond separates the CCR surface impoundment from the EDG North A-Pond. The southern embankment separates the CCR surface impoundment from the EDG B-Pond. The east embankment of the EDG South A-Pond has a height of approximately 26 feet from the crest to the toe of the downstream slope of the embankment at its greatest height. The interior storage depth of the EDG South A-Pond is approximately 25 feet. Currently, the total volume of impounded CCR and water within the EDG North A-Pond is approximately 90,500 cubic yards.

3.3.4 Foundation and Abutment Properties - §257.73(c)(1)(v)

As discussed in a Groundwater Assessment Report²², dated September 1997, the unconsolidated materials in the site primarily consist of glacial till with some lacustrine and alluvial deposits. Based on site boring logs, local private well logs, and geologic cross sections, the glacial sediment is predominately silt and clay with some sand intervals. The glacial deposits are underlain by the Silurian dolomite in most areas, although a small thickness of the Devonian Milwaukee Formation (mostly dolomite) may overlie the Silurian in some areas. The bedrock, which is encountered at depths ranging from 75 to 140 feet below ground surface, generally slopes to the south in the vicinity of the site.

As identified in a Safety Factor Assessment²³ prepared for EDG in accordance with §257.73(e) of the CCR Rule, the embankments foundation consist of medium dense to very loose silt starting at elevation 586 feet and extending to a medium stiff clay at an elevation of 560 to 569 feet.

²¹ Annual Inspection Report, Edgewater Generating Station, 2016, Hard Hat Environmental Services

²² Groundwater Assessment Report – Edgewater Closed Ash Disposal Facility, Wisconsin Power and Light Company, September 1997, RMT, Inc.

²³ Safety Factor Assessment, Edgewater Generating Station, 2016, Hard Hat Environmental Services
Wisconsin Power and Light Company – Edgewater Generating Station



3.3.5 Historical Construction and Use - §257.73(c)(1)(vi)

The EDG South A-Pond (formerly identified as a portion of the eastern part of the ash disposal facility in historical drawings) was constructed in 1969 in an area located west of the generating plant, west of Lakeshore Drive. After review of readily available information there were no known historical drawings that identify the initial layout of the ash disposal area or the initial layout of the EDG South A-Pond.

The only known readily available document that detailed the method of site preparation and construction of the ash disposal facility was in a Groundwater Assessment Report²⁴ dated September 1997. The report states the unlined closed ash disposal facility was constructed by excavating native soil, which consisted mostly of silt and clay, and mounding the excavated soil to form a perimeter berm. In addition to the Groundwater Assessment Report, historical drawings from 1976 (See Appendix A) identify the existing topography and layout of the ash disposal area prior to construction of the EDG South A-Pond.

At the time of initial construction, the ash disposal facility became the primary receiver of CCR. The initial CCR sluiced to the ash disposal facility included boiler slag from Unit 1, Unit 2, and Unit 3. As identified in historical drawings (See Appendix A) and historical aerial photographs (See Appendix B), the layout of the ash disposal facility consisted of one large CCR surface impoundment. A secondary pond was constructed adjacent to the southeast side of the CCR surface impoundment for decanting effluent from the ash disposal facility. The initial hydraulic structure associated with the ash disposal facility consisted of an overflow weir that was constructed along the perimeter berm between the ash disposal facility and the secondary pond.

In addition to slag from Unit 1, Unit 2, and Unit 3 being sluiced to the ash disposal facility, CCR from Unit 4 was sluiced to the ash disposal facility with its initial operation in 1969.

²⁴ Groundwater Assessment Report – Edgewater Closed Ash Disposal Facility, Wisconsin Power and Light Company, September 1997, RMT, Inc.



The CCR produced from Unit 4 included both slag and fly ash, as well as air heater ash. The slag that was produced was sluiced from the boiler furnace to the ash disposal facility. The fly ash that was produced by Unit 4 was carried as particulate matter by the flue gases into the electrostatic precipitators where it was electrostatically precipitated and collected. The fly ash that was collected was then sluiced to the ash disposal facility. The air heater ash that was produced was also sluiced to the ash disposal facility.

In 1977, electrostatic precipitators were constructed for Unit 3. The fly ash that was produced by Unit 3 was carried as particulate matter by the flue gases into the electrostatic precipitators where it was electrostatically precipitated and collected. The fly ash that was collected was then sluiced to the ash disposal facility, along with the slag produced by Unit 3.

A historical aerial photograph from 1978 (See Appendix B) identifies the first known modifications to the ash disposal facility with the construction of the EDG North A-Pond (formerly identified as North WPDES Basin in historical drawings) and EDG South A-Pond (formerly identified as South WPDES Basin in historical drawings). At some point between 1969 and 1978 the current layout of the EDG South A-Pond was constructed, however, the exact timeframe for this cannot be confirmed.

In 1983, Unit 1 and Unit 2 at EDG were retired. Slag that was formerly produced by the two units was no longer sluiced to the ash disposal facility. The fly ash produced by Unit 1 and Unit 2 originally was partially recovered by the mechanical cyclone separators, while the remaining portion was emitted as particulate matter from the boiler furnaces as part of the flue gas. Discussions with facility personnel with knowledge of historical operations confirmed electrostatic precipitators were eventually constructed for both Unit 1 and Unit 2, however, the timeframe for this cannot be confirmed. Once the electrostatic precipitators were constructed the fly ash produced by Unit 1 and Unit 2 would have been sluiced to the ash disposal facility until the two units were retired.



In 1985, EDG modified CCR operations with the conversion from sluiced fly ash to a dry fly ash handling system. The conversion involved Unit 3 and Unit 4. The fly ash that was collected by the electrostatic precipitators, for both Unit 3 and Unit 4, was pneumatically conveyed to the Unit 4 fly ash storage silo as it ceased being sluiced to the ash disposal facility. Following conversion to a dry fly ash handling system, EDG initiated closure of the western portion of the ash disposal facility. As discussed in a Groundwater Assessment Report²⁵ dated September 1997, dry fly ash from Unit 3 and Unit 4 was used to bring the western portion of the ash disposal facility to final grades. A clay cap was placed on the closed ash disposal facility in 1986. The CCR surface impoundments that remained after closure of the western portion of the ash disposal facility included the EDG Slag Pond (formerly identified as the slag basin in historical drawings), the EDG North A-Pond (formerly identified as the north WPDES basin), and the EDG South A-Pond (formerly identified as the south WPDES basin). With the closure of the western portion of the ash disposal facility also came the incorporation of the EDG B-Pond (formerly identified as the primary pond in historical drawings), which is located in the southeast corner of the initial ash disposal facility. The EDG B-Pond consists of the facility's original hydraulic structure that discharges into the EDG C-Pond (formerly identified as the secondary pond in historical drawings).

In-situ soil properties of the EDG South A-Pond were identified in a Safety Factor Assessment prepared for EDG in accordance with §257.73(e) of the CCR Rule. As discussed in the Safety Factor Assessment, soil borings were installed in 2010 (Appendix D). The soil boring data observed the embankments of the EDG South A-Pond to be constructed of very stiff to stiff compacted clay (CL).

The following list provides a general overview of known modifications associated with the EDG South A-Pond since construction of the initial ash disposal facility.

²⁵ Groundwater Assessment Report – Edgewater Closed Ash Disposal Facility, Wisconsin Power and Light Company, September 1997, RMT, Inc.
Wisconsin Power and Light Company – Edgewater Generating Station
History of Construction
September 21, 2016



- The existing hydraulic structure associated with the EDG South A-Pond was installed. The existing hydraulic structure consists of an 18-inch diameter CPP. Water within the EDG South A-Pond flows through the hydraulic structure into a concrete sluice box. The water within the sluice box flows through a Parshall flume structure and into the 48-inch diameter CMP that connects the EDG Slag Pond to the EDG B-Pond. The timeframe of this modification has not been documented.
- The instrumentation associated with the EDG South A-Pond, as well as the EDG North A-Pond, includes a Parshall flume structure and flow monitoring equipment. The Parshall flume and flow monitoring equipment were installed northwest of the EDG South A-Pond. The timeframe of this modification has not been documented.
- The 48-inch diameter CMP that connects the EDG Slag Pond to the EDG B-Pond was installed. The 48-inch diameter CMP includes influent flows from the EDG Slag Pond, EDG North A-Pond, and EDG South A-Pond. The timeframe of this modification has not been documented.
- The EDG South A-Pond ceased being a primary receiver of Unit 5 bottom ash. The timeframe of this modification has not been documented.

Historical aerial photographs (See Appendix B) and historical topographic maps (See Appendix C) identify the topographic changes to the EDG South A-Pond that have occurred since the time of initial facility operations.

3.3.6 Structures, Appurtenances, and Operations- §257.73(c)(1)(vii)

Detailed dimensional drawings of the EDG South A-Pond that were reasonably and readily available are identified below. The detailed dimensional drawings were obtained from various designs, plans, and reports that were assembled during the historical information review.



- Edgewater Ash Disposal Site (1976) – Drawings prepared by Donohue & Associates, Inc. provides existing topography and layout of the ash disposal facility, as well as proposed site development plans and cross-sections (Appendix A).
- Edgewater Closed Ash Disposal Facility (1991) – Drawings prepared by Dames & Moore provides layout and cross-sections of the modifications to the ash disposal facility after closure, inclusive of the EDG Slag Pond (slag basin), EDG North A-Pond (North WPDES Basin), EDG South A-Pond (South WPDES Basin), EDG B-Pond (Primary Pond), and EDG C-Pond (Secondary Pond). Drawings also provide water table and aquifer mapping (Appendix E).
- Edgewater Generating Station Ash Pond Evaluation (2011) – Drawings prepared by Miller Engineers Scientists provides topographic layout and cross-sections of the EDG South A-Pond (Appendix E).
- Coal Pile Runoff Pond Study (2015) – Bathymetric survey by Burns & McDonnell Engineering Company, Inc. was completed for the EDG South A-Pond. Drawings provided identify the bathymetric surface (Appendix E).

3.3.7 Instrumentation - §257.73(c)(1)(viii)

Instrumentation used to support the operation of the EDG South A-Pond consists of a Parshall flume discharge structure and equipment to measure the flow of the combined discharged water of the EDG North A-Pond and EDG South A-Pond. The instrumentation is located near the northwest corner of the EDG South A-Pond.

3.3.8 Area-Capacity Curve - §257.73(c)(1)(ix)

An area-capacity curve identifies the relationship between the surface area of the existing CCR surface impoundment and an elevation, which corresponds to an available storage capacity. After review of readily available historical documents there is no readily available information regarding area-capacity curves for the EDG South A-Pond.



3.3.9 Spillway and Diversion Features - §257.73(c)(1)(x)

The EDG South A-Pond is equipped with one hydraulic structure located in the northwest corner of the existing CCR surface impoundment. The hydraulic structure consists of an 18-inch diameter CPP. Water within the EDG South A-Pond flows to the northwest corner of the existing CCR surface impoundment and through the hydraulic structure. The hydraulic structure is constructed of non-erodible material and designed to carry sustained flows. Additional information regarding the hydraulic capacity of the hydraulic structure associated with the EDG South A-Pond is provided in the Inflow Flood Control Plan²⁶.

3.3.10 Construction Specifications, Surveillance, Maintenance, and Repair - §257.73(c)(1)(xi)

EDG implements a Site-Specific Inspection and Maintenance (I&M) Plan²⁷, in accordance with an Alliant Energy I&M Plan²⁸. The Site-Specific I&M Plan has been implemented at EDG in order to identify the factors which may affect the long-term stability of the existing CCR surface impoundment. The Site-Specific I&M Plan identifies existing operation and maintenance activities, and identifies the inspection, monitoring, maintenance, and recordkeeping requirements as outlined in the Alliant Energy I&M Plan in order to maintain the integrity of the existing CCR surface impoundment.

Visual inspections of the EDG South A-Pond are completed in accordance with §257.83 of the CCR Rule. At intervals not exceeding seven days, the EDG South A-Pond is visually inspected for any appearances of structural weakness or other conditions which are disrupting or have the potential to disrupt the operation or safety of the existing CCR surface impoundment. In addition to seven-day inspections, EDG conducts 30-Day instrumentation inspections and event-related inspections which may include inspections following storm events, seismic events, major maintenance activities, as well as other unusual events. Annual inspections are conducted by a qualified PE who is

²⁶ Inflow Flood Control Plan, Edgewater Generating Station, 2016, Hard Hat Environmental Services

²⁷ Inspection and Maintenance (I&M) Plan, Edgewater Generating Station, October 2015, Version 2.0-Revision 0.0

²⁸ Inspection and Maintenance (I&M) Plan, Alliant Energy, September 2015, Version 2.0-Revision 0.0

Wisconsin Power and Light Company – Edgewater Generating Station

History of Construction
September 21, 2016



familiar with the requirements of the CCR Rule, the Alliant Energy I&M Plan, the EDG Site-Specific I&M Plan, and other facility specific information pertaining to the existing CCR surface impoundment.

Maintenance activities that are completed at EDG may include routine maintenance, event-related maintenance, and long-term maintenance. Routine maintenance activities may include management of vegetation (or other forms of slope protection), tree and sapling removal, reseeding of disturbed vegetated areas, removal of debris from collection and diversion channels, and repair of eroded areas. Event-related maintenance activities may include maintenance after unusual events such as heavy rainfall, periods of very high winds, or seismic activity. Maintenance may include repair of eroded areas or removal of damaged vegetation. Long-term maintenance activities are identified as part of the ongoing inspection program, through the annual inspections, or through other engineering evaluations and may include larger remediation activities.

3.3.11 Structural Instability Records - §257.73(c)(1)(xii)

After review of readily available historical documents there are no known records of structural instability associated with the EDG South A-Pond that were identified.

3.4 EDG B-Pond

The following subsections are intended to meet the requirements of the CCR Rule §257.73(c)(1) for the EDG B-Pond.

3.4.1 CCR Unit Location - §257.73(c)(1)(ii)

The EDG B-Pond is located southwest of the generating plant, south of the EDG South A-Pond, and west of the EDG C-Pond. The location of the EDG B-Pond, in reference to the surrounding topography, is identified on both a USGS 7 ½ minute topographic quadrangle map and aerial photograph on Figure 1. The location of the EDG B-Pond, in reference to the immediate surroundings within the EDG property, is identified on Figure 2.



3.4.2 Statement of Purpose - §257.73(c)(1)(iii)

The EDG B-Pond receives influent flow via a 48-inch diameter CMP. The 48-inch diameter CMP consists of a combined flow from the EDG Slag Pond, EDG North A-Pond (presently no discharge), and EDG South A-Pond. Additionally, the EDG B-Pond receives storm water drainage from a portion of the closed ash disposal facility located west of the EDG B-Pond. The storm water from the closed ash disposal facility discharges into the west side of the EDG B-Pond via a small diameter CPP.

The water in the EDG B-Pond flows to the east through an overflow weir structure, which is also the original hydraulic structure associated with the initial ash disposal facility. CCR that does not settle in the EDG Slag Pond or EDG A-Ponds settles in the EDG B-Pond. As determined by WPL, process water discharging from the EDG B-Pond does not contain a significant quantity of CCR, and downstream impoundments contain only de minimis quantities of CCR. The water gravity flows to the east through a 24-inch diameter CMP where it discharges into the west side of the EDG C-Pond. The water in the EDG C-Pond gravity flows a significant length to the east through two CMPs. The northeast corner of the EDG C-Pond consists of a 20-inch diameter CMP while the southeast corner of the EDG C-Pond consists of a 24-inch diameter CMP. The two CMPs tie in together prior to discharging into the EDG F-Pond which is located south of the generating plant. The EDG F-Pond also receives influent flows from the EDG E-Pond. The EDG E-Pond, located south of the EDG F-Pond, collects storm water runoff from the coal pile storage area. The water that accumulates in the EDG F-Pond flows to the east through the facility's Wisconsin Pollution Discharge Elimination System (WPDES) Outfall 004 and discharges into Lake Michigan.

3.4.3 Physical Layout Information - §257.73(c)(1)(iv)

As identified in an Inflow Flood Control Plan²⁹ prepared for EDG in accordance with §257.82 of the CCR Rule, the EDG B-Pond has a watershed of approximately 5.5 acres.

²⁹ Inflow Flood Control Plan, Edgewater Generating Station, 2016, Hard Hat Environmental Services
Wisconsin Power and Light Company – Edgewater Generating Station
History of Construction
September 21, 2016



The drainage area includes the surface area of the EDG B-Pond, as well as a portion of the closed ash disposal facility located to the west of the EDG B-Pond.

As discussed in an Annual Inspection Report³⁰ prepared for EDG in accordance with §257.83 of the CCR Rule, the EDG B-Pond is incised along the west side of the CCR Unit. The northern embankment of the EDG B-Pond separates the CCR surface impoundment from the EDG South A-Pond. The eastern embankment separates the CCR surface impoundment from the EDG C-Pond. The south embankment of the EDG B-Pond has a height of approximately 24 feet from the crest to the toe of the downstream slope of the embankment at its greatest height. The interior storage depth of the EDG South A-Pond is approximately 15 feet. Currently, the total volume of impounded CCR and water within the EDG North A-Pond is approximately 46,500 cubic yards.

3.4.4 Foundation and Abutment Properties - §257.73(c)(1)(v)

As discussed in a Groundwater Assessment Report³¹, dated September 1997, the unconsolidated materials in the site primarily consist of glacial till with some lacustrine and alluvial deposits. Based on site boring logs, local private well logs, and geologic cross sections, the glacial sediment is predominately silt and clay with some sand intervals. The glacial deposits are underlain by the Silurian dolomite in most areas, although a small thickness of the Devonian Milwaukee Formation (mostly dolomite) may overlie the Silurian in some areas. The bedrock, which is encountered at depths ranging from 75 to 140 feet below ground surface, generally slopes to the south in the vicinity of the site.

As identified in a Safety Factor Assessment³² prepared for EDG in accordance with §257.73(e) of the CCR Rule, the embankments foundation consist of medium dense to very loose silt starting at elevation 586 feet and extending to a medium stiff clay at an elevation of 560 to 569 feet.

³⁰ Annual Inspection Report, Edgewater Generating Station, 2016, Hard Hat Environmental Services

³¹ Groundwater Assessment Report – Edgewater Closed Ash Disposal Facility, Wisconsin Power and Light Company, September 1997, RMT, Inc.

³² Safety Factor Assessment, Edgewater Generating Station, 2016, Hard Hat Environmental Services
Wisconsin Power and Light Company – Edgewater Generating Station



3.4.5 Historical Construction and Use - §257.73(c)(1)(vi)

The EDG B-Pond (formerly identified as the southeastern part of the ash disposal facility in historical drawings) was constructed in 1969 in an area located west of the generating plant, west of Lakeshore Drive. After review of readily available information there were no known historical drawings that identify the initial layout of the ash disposal area or the initial layout of the EDG B-Pond.

The only known readily available document that detailed the method of site preparation and construction of the ash disposal facility was in the Groundwater Assessment Report. The report states the unlined closed ash disposal facility was constructed by excavating native soil, which consisted mostly of silt and clay, and mounding the excavated soil to form a perimeter berm. In addition to the Groundwater Assessment Report, historical drawings from 1976 (See Appendix A) identify the existing topography and layout of the ash disposal area prior to construction of the EDG B-Pond.

At the time of initial construction, the ash disposal facility became the primary receiver of CCR. The initial CCR sluiced to the ash disposal facility included boiler slag from Unit 1, Unit 2, and Unit 3. As identified in historical drawings (Appendix A) and historical aerial photographs (Appendix B), the layout of the ash disposal facility consisted of one large CCR surface impoundment. A secondary pond was constructed adjacent to the southeast side of the CCR surface impoundment for decanting effluent from the ash disposal facility. The initial hydraulic structure associated with the ash disposal facility consisted of an overflow weir that was constructed along the perimeter berm between the ash disposal facility and the secondary pond.

In addition to slag from Unit 1, Unit 2, and Unit 3 being sluiced to the ash disposal facility, CCR from Unit 4 was sluiced to the ash disposal facility with its initial operation in 1969. The CCR produced from Unit 4 included both slag and fly ash, as well as air heater ash. The slag that was produced was sluiced from the boiler furnace to the ash disposal facility. The fly ash that was produced by Unit 4 was carried as particulate matter by the



flue gases into the electrostatic precipitators where it was electrostatically precipitated and collected. The fly ash that was collected was then sluiced to the ash disposal facility. The air heater ash that was produced was also sluiced to the ash disposal facility.

In 1977, electrostatic precipitators were constructed for Unit 3. The fly ash that was produced by Unit 3 was carried as particulate matter by the flue gases into the electrostatic precipitators where it was electrostatically precipitated and collected. The fly ash that was collected was then sluiced to the ash disposal facility, along with the slag produced by Unit 3.

A historical aerial photograph from 1978 (See Appendix B) identifies the first known modifications to the ash disposal facility. A historical aerial photograph from 1987 (See Appendix B) identifies the construction of the EDG B-Pond (formerly identified as Primary Pond). At some point between 1981 and 1987 the current layout of the EDG B-Pond was constructed, however, the exact timeframe for this cannot be confirmed.

In 1985, EDG modified CCR operations with the conversion from sluiced fly ash to a dry fly ash handling system. The conversion involved Unit 3 and Unit 4. The fly ash that was collected by the electrostatic precipitators, for both Unit 3 and Unit 4, was pneumatically conveyed to the Unit 4 fly ash storage silo as it ceased being sluiced to the ash disposal facility. Following conversion to a dry fly ash handling system, EDG initiated closure of the western portion of the ash disposal facility. As discussed in a Groundwater Assessment Report³³ dated September 1997, dry fly ash from Unit 3 and Unit 4 was used to bring the western portion of the ash disposal facility to final grades. A clay cap was placed on the closed ash disposal facility in 1986. The CCR surface impoundments that remained after closure of the western portion of the ash disposal facility included the EDG Slag Pond (formerly identified as the slag basin in historical drawings), the EDG North A-Pond (formerly identified as the north WPDES basin), and

³³ Groundwater Assessment Report – Edgewater Closed Ash Disposal Facility, Wisconsin Power and Light Company, September 1997, RMT, Inc.



the EDG South A-Pond (formerly identified as the south WPDES basin). With the closure of the western portion of the ash disposal facility also came the incorporation of the EDG B-Pond (formerly identified as the primary pond in historical drawings), which is located in the southeast corner of the initial ash disposal facility. The EDG B-Pond consists of the facility's original hydraulic structure that discharges into the EDG C-Pond (formerly identified as the secondary pond in historical drawings).

In-situ soil properties of the EDG B-Pond were identified in a Safety Factor Assessment prepared for EDG in accordance with §257.73(e) of the CCR Rule. As discussed in the Safety Factor Assessment, soil borings were installed in 2010 (Appendix D). The soil boring data observed the embankments of the EDG B-Pond to be constructed of very stiff to stiff compacted clay (CL).

The following list provides a general overview of known modifications associated with the EDG B-Pond since construction of the initial ash disposal facility.

- The 48-inch diameter CMP that connects the EDG Slag Pond to the EDG B-Pond was installed. The 48-inch diameter CMP includes influent flows from the EDG Slag Pond, EDG North A-Pond, and EDG South A-Pond. The timeframe of this modification has not been documented.

Historical aerial photographs (See Appendix B) and historical topographic maps (See Appendix C) identify the topographic changes to the EDG B-Pond that have occurred since the time of initial facility operations.

3.4.6 Structures, Appurtenances, and Operations- §257.73(c)(1)(vii)

Detailed dimensional drawings of the EDG B-Pond that were reasonably and readily available are identified below. The detailed dimensional drawings were obtained from various designs, plans, and reports that were assembled during the historical information review.



- Edgewater Ash Disposal Site (1976) – Drawings prepared by Donohue & Associates, Inc. provides existing topography and layout of the ash disposal facility, as well as proposed site development plans and cross-sections (Appendix A).
- Edgewater Closed Ash Disposal Facility (1991) – Drawings prepared by Dames & Moore provides layout and cross-sections of the modifications to the ash disposal facility after closure, inclusive of the EDG Slag Pond (slag basin), EDG North A-Pond (North WPDES Basin), EDG South A-Pond (South WPDES Basin), EDG B-Pond (Primary Pond), and EDG C-Pond (Secondary Pond). Drawings also provide water table and aquifer mapping (Appendix E).
- Edgewater Generating Station Ash Pond Evaluation (2011) – Drawings prepared by Miller Engineers Scientists provides topographic layout and cross-sections of the EDG B-Pond (Appendix E).
- Coal Pile Runoff Pond Study (2015) – Bathymetric survey by Burns & McDonnell Engineering Company, Inc. was completed for the EDG B-Pond. Drawings provided identify the bathymetric surface (Appendix E).

3.4.7 Instrumentation - §257.73(c)(1)(viii)

The EDG B-Pond does not have existing instrumentation that supports the operation of the CCR Unit. Additionally, review of readily available historical documents has not identified any past instrumentation that was used to support the operation of the EDG B-Pond.

3.4.8 Area-Capacity Curve - §257.73(c)(1)(ix)

An area-capacity curve identifies the relationship between the surface area of the existing CCR surface impoundment and an elevation, which corresponds to an available storage capacity. After review of readily available historical documents there is no readily available information regarding area-capacity curves for the EDG B-Pond.



3.4.9 Spillway and Diversion Features - §257.73(c)(1)(x)

The EDG B-Pond is equipped with one hydraulic structure located along the east side of the existing CCR surface impoundment. The water in the EDG B-Pond flows to the east through an overflow weir structure. The water gravity flows to the east through a 24-inch diameter corrugated metal pipe where it discharges into the west side of the EDG C-Pond. The hydraulic structure is constructed of non-erodible material and designed to carry sustained flows. Additional information regarding the hydraulic capacity of the hydraulic structure associated with the EDG B-Pond is provided in the Inflow Flood Control Plan³⁴.

3.4.10 Construction Specifications, Surveillance, Maintenance, and Repair - §257.73(c)(1)(xi)

EDG implements a Site-Specific Inspection and Maintenance (I&M) Plan³⁵, in accordance with an Alliant Energy I&M Plan³⁶. The Site-Specific I&M Plan has been implemented at EDG in order to identify the factors which may affect the long-term stability of the existing CCR surface impoundment. The Site-Specific I&M Plan identifies existing operation and maintenance activities, and identifies the inspection, monitoring, maintenance, and recordkeeping requirements as outlined in the Alliant Energy I&M Plan in order to maintain the integrity of the existing CCR surface impoundment.

Visual inspections of the EDG B-Pond are completed in accordance with §257.83 of the CCR Rule. At intervals not exceeding seven days, the EDG B-Pond is visually inspected for any appearances of structural weakness or other conditions which are disrupting or have the potential to disrupt the operation or safety of the existing CCR surface impoundment. In addition to seven-day inspections, EDG conducts event-related inspections which may include inspections following storm events, seismic events, major maintenance activities, as well as other unusual events. Annual inspections are conducted by a qualified PE who is familiar with the requirements of the CCR Rule, the

³⁴ Inflow Flood Control Plan, Edgewater Generating Station, 2016, Hard Hat Environmental Services

³⁵ Inspection and Maintenance (I&M) Plan, Edgewater Generating Station, October 2015, Version 2.0-Revision 0.0

³⁶ Inspection and Maintenance (I&M) Plan, Alliant Energy, September 2015, Version 2.0-Revision 0.0

Wisconsin Power and Light Company – Edgewater Generating Station

History of Construction
September 21, 2016



Alliant Energy I&M Plan, the EDG Site-Specific I&M Plan, and other facility specific information pertaining to the existing CCR surface impoundment.

Maintenance activities that are completed at EDG may include routine maintenance, event-related maintenance, and long-term maintenance. Routine maintenance activities may include management of vegetation (or other forms of slope protection), tree and sapling removal, reseeding of disturbed vegetated areas, removal of debris from collection and diversion channels, and repair of eroded areas. Event-related maintenance activities may include maintenance after unusual events such as heavy rainfall, periods of very high winds, or seismic activity. Maintenance may include repair of eroded areas or removal of damaged vegetation. Long-term maintenance activities are identified as part of the ongoing inspection program, through the annual inspections, or through other engineering evaluations and may include larger remediation activities.

3.4.11 Structural Instability Records - §257.73(c)(1)(xii)

After review of readily available historical documents there are no known records of structural instability associated with the EDG B-Pond that were identified.



4 CHANGES TO THE HISTORY OF CONSTRUCTION

If there is a significant change to any information compiled within the Report, the owner or operator of the CCR unit must update the relevant information and place into the facility's operating record as required by §257.105(f)(9).



FIGURES

Alliant Energy
Wisconsin Power and Light Company
Edgewater Generating Station
Sheboygan, Wisconsin

History of Construction



Historical Topo Map

2013



Historical Aerial Photo

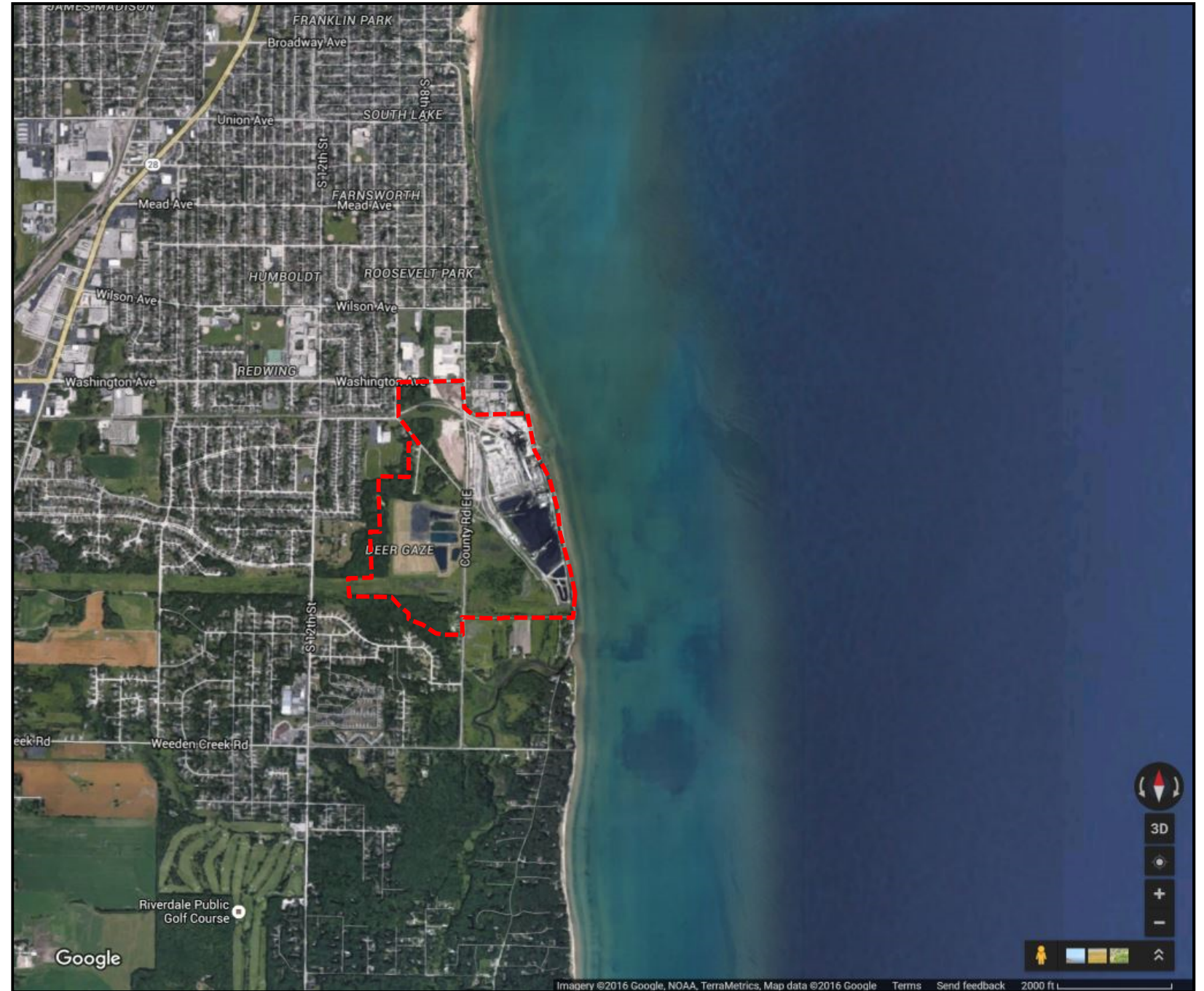

This report includes information from the following map sheet(s).

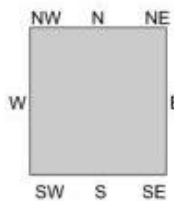

TP, Sheboygan South, 2013, 7.5-minute

SITE NAME: Edgewater Generating Station
ADDRESS: 3739 Lakeshore Drive
 Sheboygan, WI 53081
CLIENT: Environmental Site Assessors



----- Approximate Property Boundary



Site Location
 Edgewater Generating Station
 Wisconsin Power and Light Company

Drawing
Figure 1
 Date
 7/12/2016

MAP SOURCE:
 MODIFIED FROM MILLER ENGINEERS
 SCIENTISTS, ASH POND SLOPE STABILITY
 EVALUATION, IMPOUNDMENT ANALYSIS,
 SHEET 1 OF 5, FEB. 25, 2011.

LEGEND

- MILLER ENGINEERS & SCIENTISTS JANUARY AND FEBRUARY 2011 SOIL EXPLORATION BORINGS & GROUND ELEVATION MEASUREMENTS
- BERM CROSS SECTION LOCATION

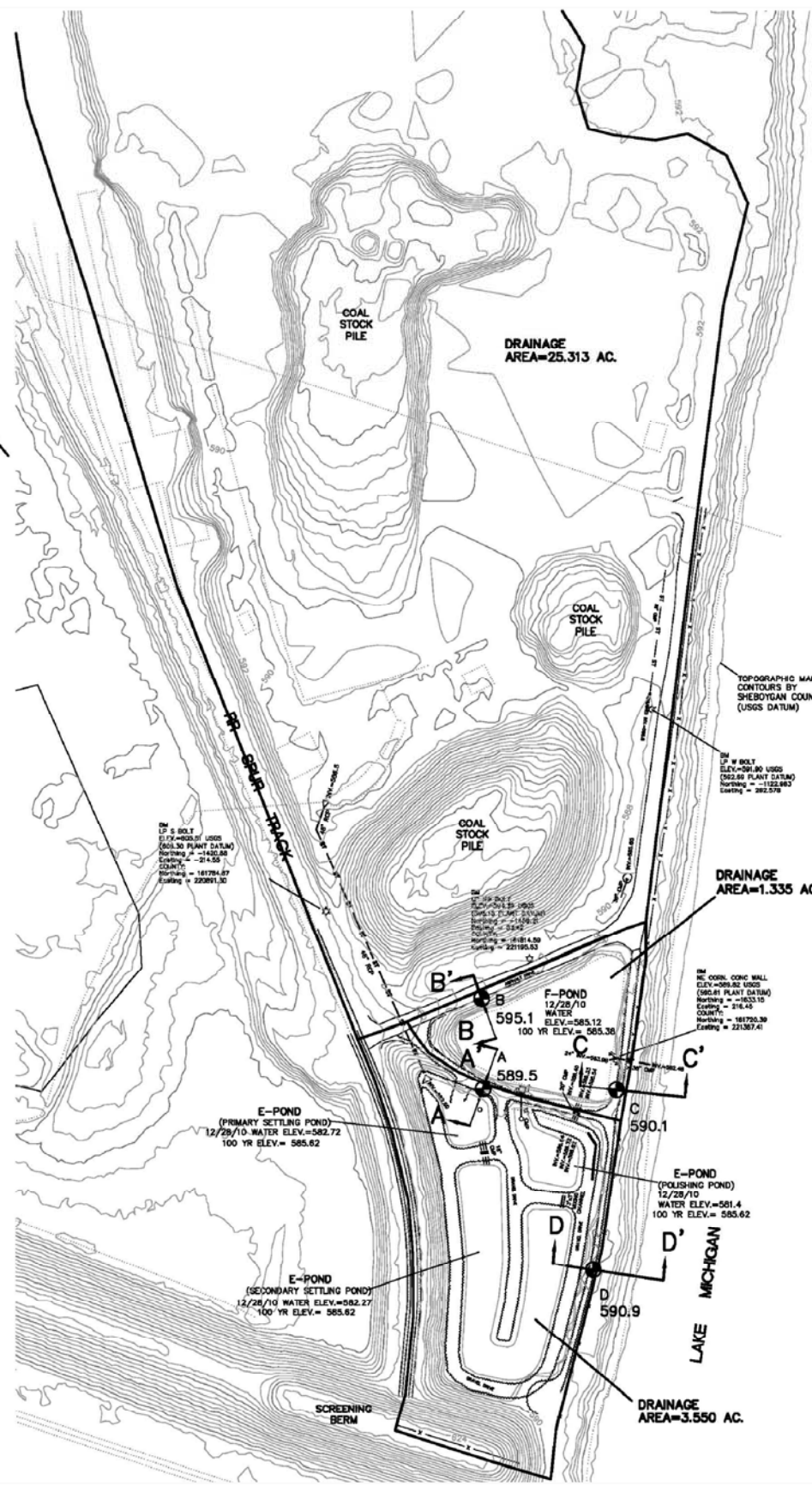
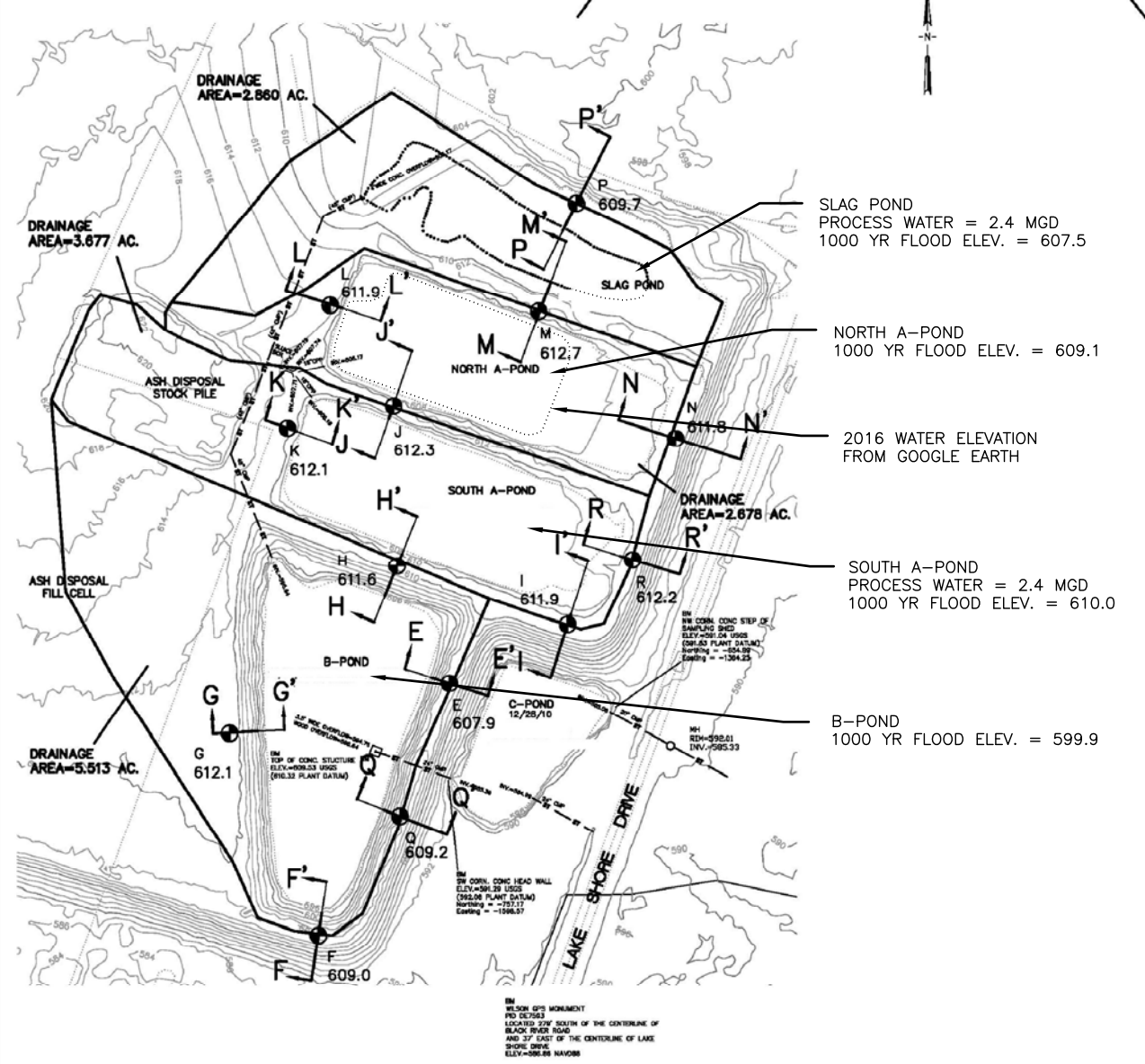

LAKE MICHIGAN

CALM WATER LEVEL: 2/20/11=589.0 ft
 HISTORIC HIGH (1985): 582.8 ft
 HISTORIC LOW (1984): 579.2 ft
 HISTORIC AVERAGE: 578.0 ft

TRUE NORTH

PLANT GRID NORTH

GRAPHIC SCALE
 0 100 0
 (IN FEET)
 1 inch = 100 ft.

ELEVATIONS IN NGVD DATUM UNLESS NOTED OTHERWISE. PLANT DATUM= NGVD+ 0.78'

NOTICE
 THIS DRAWING IS THE PROPERTY
 OF HARD HAT SERVICES AND IS
 NOT TO BE REPRODUCED,
 CHANGED, OR COPIED IN ANY FORM
 OR MANNER WITHOUT PRIOR
 WRITTEN PERMISSION. ALL RIGHTS
 RESERVED.

REV	DATE	BY	DESCRIPTION



SCALE: AS SHOWN
 DATE: 7-13-16
 DRAWN BY: JFD
 CHKD BY: ---
 APRVD BY: ---

CLIENT / LOCATION
 INTERSTATE POWER AND LIGHT (IPL)
 OTTUMWA GENERATING STATION
 OTTUMWA, IA

DRAWING DESCRIPTION
 History of Construction
 STORM AND PROCESS WATER ROUTING

JOB: -----
 SHT. FIGURE 2
 DWG. -----

APPENDIX A – Edgewater Ash Disposal Site - 1976

Alliant Energy
Wisconsin Power and Light Company
Edgewater Generating Station
Sheboygan, Wisconsin

History of Construction



WISCONSIN POWER & LIGHT COMPANY

EDGEWATER GENERATING STATION

EDGEWATER ASH DISPOSAL SITE

SHEBOYGAN COUNTY, WISCONSIN

DONOHUE & ASSOCIATES, INC.
 CONSULTING ENGINEERS
 SHEBOYGAN, WISCONSIN

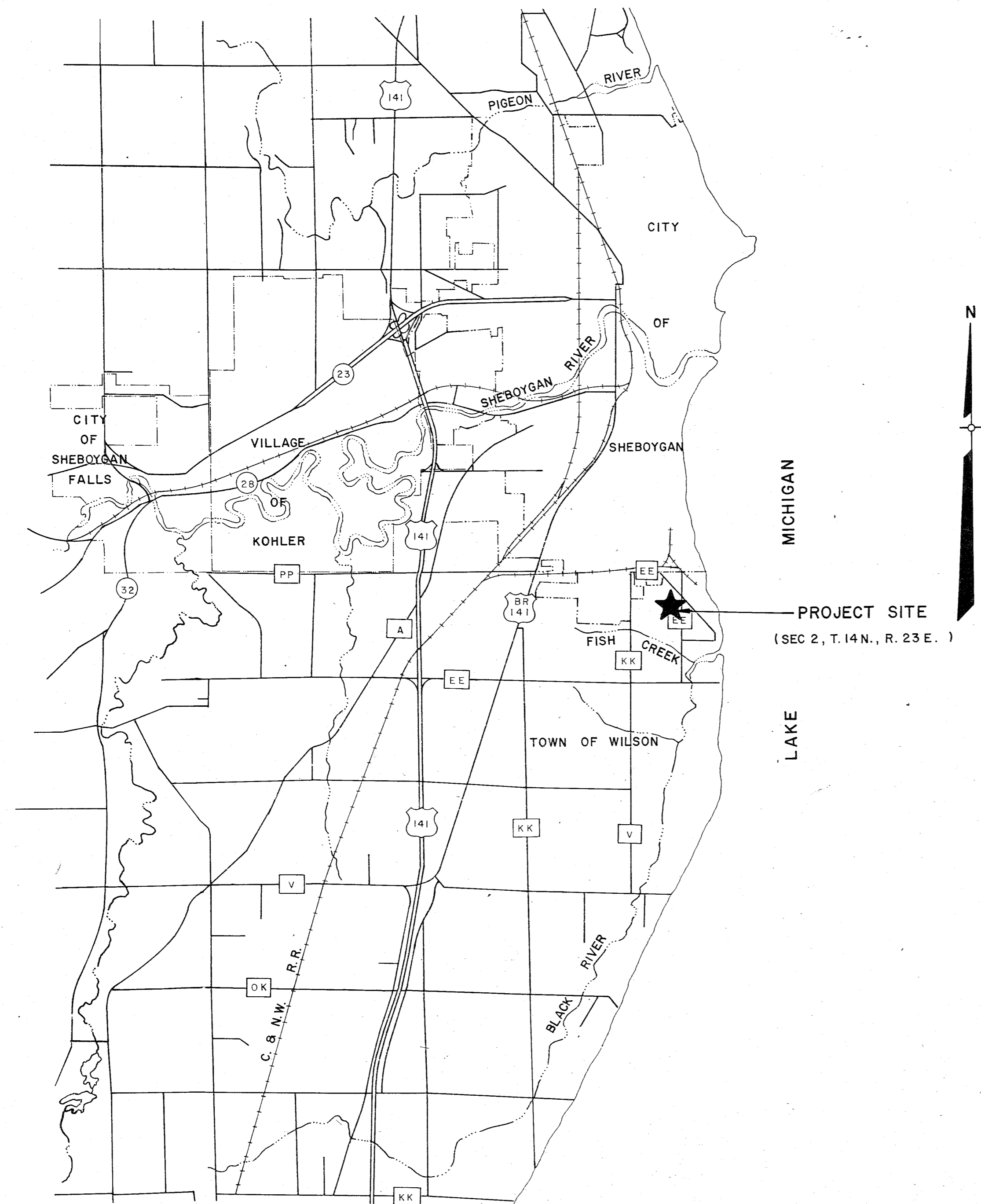

INDEX

1. TITLE, INDEX & LOCALITY MAP	A-32259
2. LAND USE AND ZONING	A-32258
3. SOILS INVENTORY & BORING LOCATIONS	A-32257
4. EXISTING TOPOGRAPHY AND SITE OPERATION	A-32256
5. EXISTING ASH SITE TOPOGRAPHY	A-32255
6. PROGRESSIVE SITE OPERATION PLAN	A-32254
7. PROPOSED FUTURE DEVELOPMENT PLAN	A-32253
8. CROSS SECTIONS,	A-32252
9. CROSS SECTIONS,	A-32251
10. CROSS SECTIONS,	A-32250
11. CROSS SECTIONS,	A-32249

*Print A32256 taken on 4/10/76 to
 mark off ash tanks and well.
 9/11
 Returned gms*

DATE APRIL, 1976
 REVISIONS
 DRAWN BY D.K. O'Leary
 CHECKED BY J.W. Reiff
 SCALE 1" = 2000'

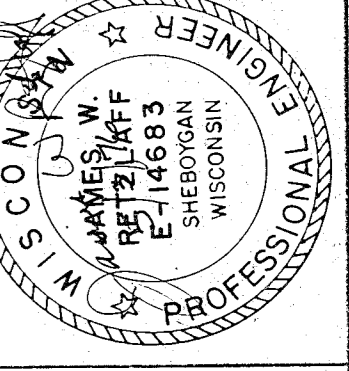

DONOHUE & ASSOCIATES, INC.
 CONSULTING & DESIGN ENGINEERS
 SHEBOYGAN, WISCONSIN

EDGEWATER ASH DISPOSAL SITE
 TITLE, INDEX & LOCALITY MAP
 SHEBOYGAN COUNTY, WISCONSIN

PROJECT NO.
 4372
 SHEET NO.
 I OF II
 FILE NO.
 A-32259

April 76



LEGEND

- ⊙ PRIVATE WELL
- (0000) ELEVATION OF ROCK (SOURCE - WELL DRILLERS LOG)
- ↔ DRY RUN
- ~ INTERMITTENT STREAM
- - - - WISCONSIN POWER & LIGHT PROPERTY LINE
- CEMETERIES
- ▨ RESIDENCES
- ▧ INDUSTRIAL BLDGS.
- CITY LIMITS

NOTE:
ALL RESIDENCES IN TOWN OF WILSON
HAVE PRIVATE WELLS

**EDGEWATER ASH DISPOSAL SITE
LAND USE AND ZONING
SHEBOYGAN COUNTY, WISCONSIN**

PROJECT NO.
4372

SHEET NO.
2 OF 11

FILE NO.
A-32258

DONOHUE & ASSOCIATES, INC.
CONSULTING & DESIGN ENGINEERS
SHEBOYGAN, WISCONSIN

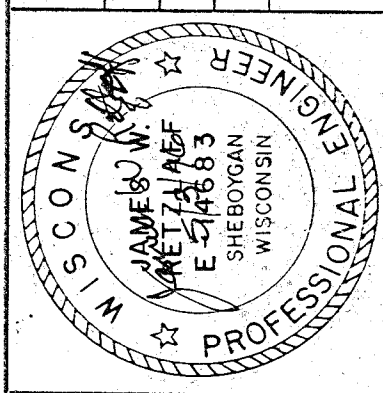

DATE APRIL, 1976

REVISIONS

DRAWN BY *OKO*

CHECKED BY *J.W. Kelly*

SCALE 1" = 500'



APPROXIMATE MEAN LAKE ELEVATION = 580'



LEGEND

- YAHARA SILT LOAM. SOMEWHAT POORLY DRAINED. LOAMY SOILS FORMED IN CALCAREOUS SAND AND SILT. SEASONAL HIGH WATER TABLE, 1-3 FEET. MODERATELY PERMEABLE.
- MARTINTON SILT LOAM - POORLY DRAINED, FINE TEXTURED SOILS UNDERLAIN BY SILT AND CLAY. SEASONAL HIGH WATER TABLE, 1-3 FEET. OCCASIONAL FLOODING.
- SAYLESVILLE SILT LOAM - WELL AND MODERATELY WELL DRAINED, MEDIUM TO FINE TEXTURED SOILS UNDERLAIN BY SILT AND CLAY LAKE SEDIMENTS. SEASONAL HIGH WATER TABLE, 3-6 FEET. HIGH SHRINK-SWELL POTENTIAL.
- TEDROW LOAMY FINE SAND. POORLY DRAINED SANDY SOILS OVER SAND. SEASONAL HIGH WATER TABLE, 1-3 FEET. RAPID PERMEABILITY.
- OAKVILLE LOAMY FINE SAND - WELL DRAINED SANDY SOIL OVER SAND. SEASONAL HIGH WATER TABLE MORE THAN 3 FEET. RAPID PERMEABILITY.
- ALLUVIAL LAND, WET.
- COLWOOD SILT LOAM - POORLY DRAINED SILTY CLAY LOAM AND SILT LOAM OVER STRATIFIED VERY FINE SAND AND SILT. SEASONAL HIGH WATER TABLE, 0-1 FOOT. FREQUENT FLOODING.
- MONTGOMERY SILTY CLAY LOAM - VERY POORLY DRAINED FINE TEXTURED SOILS. SEASONAL HIGH WATER TABLE, 0-1 FOOT. FREQUENT FLOODING.
- SOIL BORING LOCATION

**EDGEWATER ASH DISPOSAL SITE
SOILS INVENTORY & BORING LOCATIONS
SHEBOYGAN COUNTY, WISCONSIN**

DONOHUE & ASSOCIATES, INC.
CONSULTING & DESIGN ENGINEERS
SHEBOYGAN, WISCONSIN

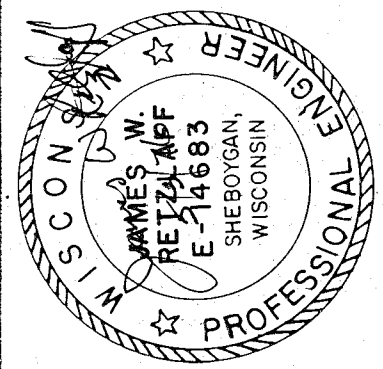

DATE APRIL, 1976
REVISIONS
DRAWN BY D.K. O'Leary
CHECKED BY J.W. Retzlaff
SCALE 1" = 500'

PROJECT NO.
4372
SHEET NO.
3 OF 11
FILE NO.
A-32257



DATE APRIL, 1976
 REVISIONS
 DRAWN BY D.K. O'Leary
 CHECKED BY J.W. R. [Signature]
 SCALE 1" = 200'

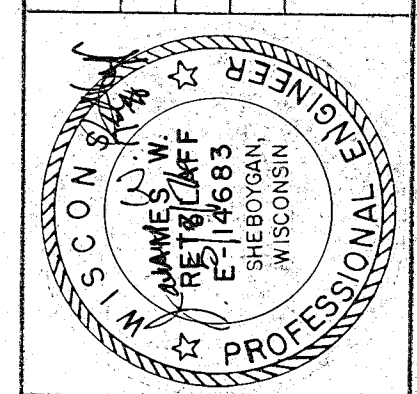

DONOHUE & ASSOCIATES, INC.
 CONSULTING & DESIGN ENGINEERS
 SHEBOYGAN, WISCONSIN

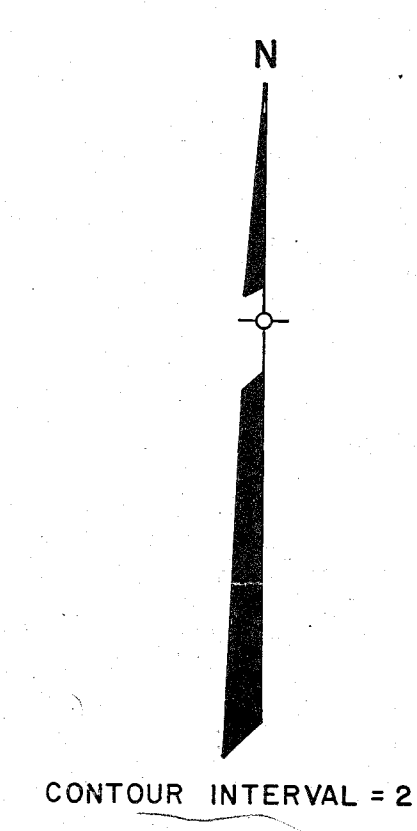

LAKE MICHIGAN
 APPROXIMATE MEAN LAKE ELEVATION = 580'

LEGEND
 O SOIL BORING LOCATION
 ▼ DOWNWARD SLOPE

X well
 □ septic tank

EDGEWATER ASH DISPOSAL SITE
EXISTING TOPOGRAPHY AND SITE OPERATION
 SHEBOYGAN COUNTY, WISCONSIN

PROJECT NO. 4372
 SHEET NO. 4 OF 11
 FILE NO. A-32256

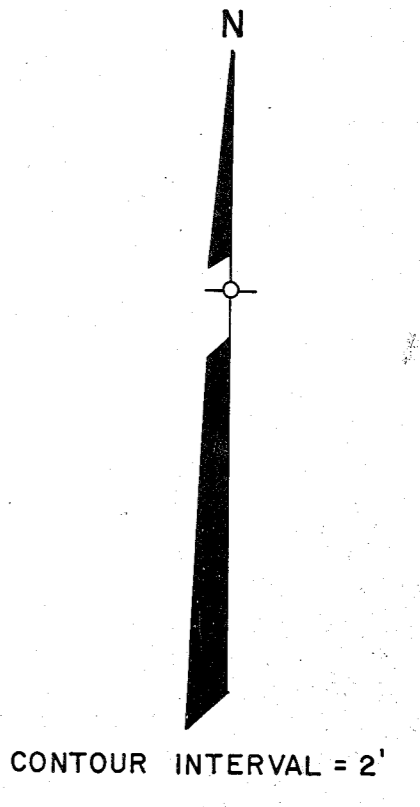
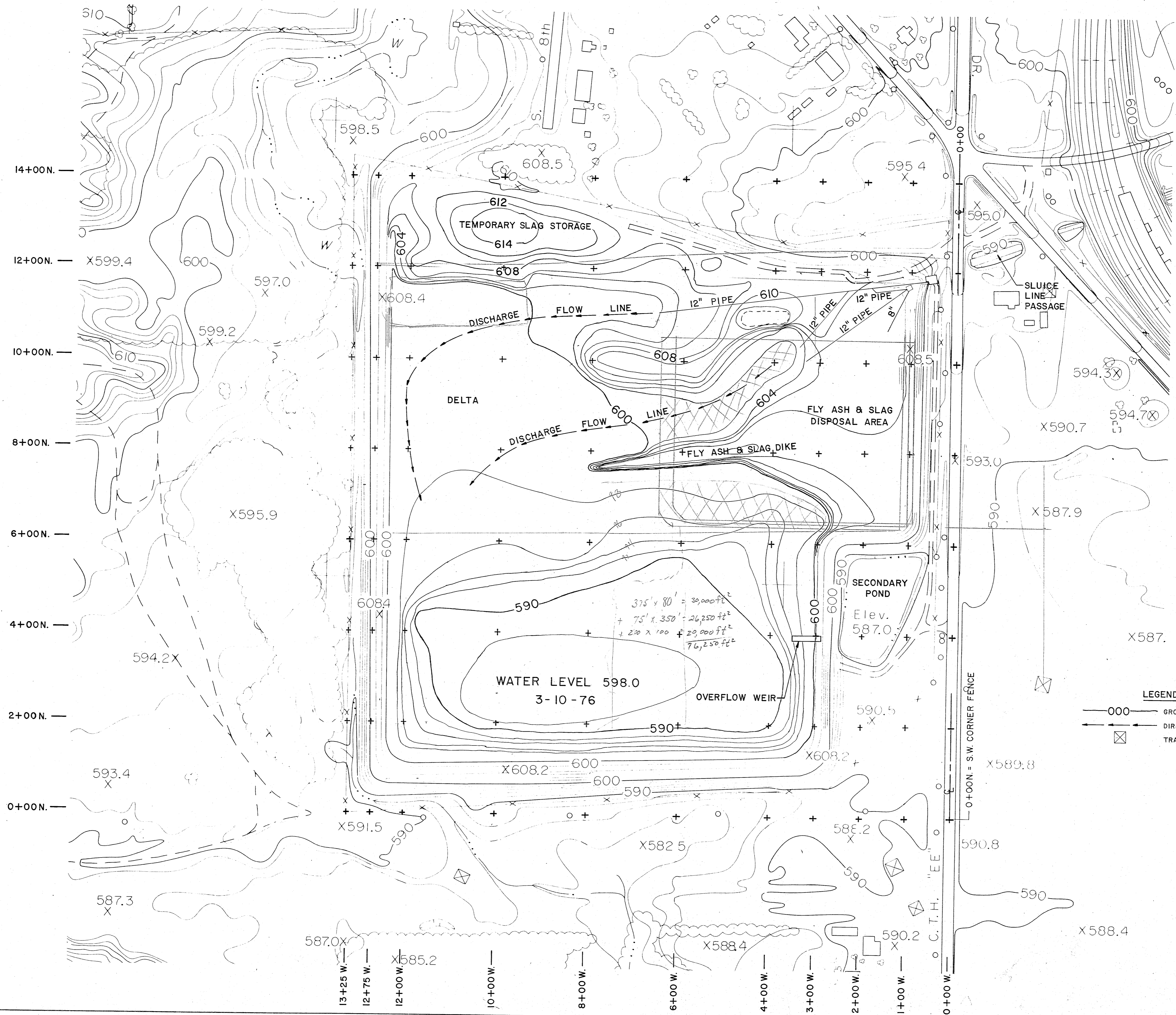

LEGEND

- 000 — GROUND ELEVATIONS
- DIRECTION OF FLOW
- ⊠ TRANSMISSION TOWER

DATE	APRIL, 1976
REVISIONS	
DRAWN BY	D.K. O'Leary
CHECKED BY	James R. O'Leary
SCALE	1" = 100'
DONOHUE & ASSOCIATES, INC. CONSULTING & DESIGN ENGINEERS SHEBOYGAN, WISCONSIN	
EDGEWATER ASH DISPOSAL SITE EXISTING ASH SITE TOPOGRAPHY SHEBOYGAN COUNTY, WISCONSIN	
PROJECT NO.	4372
SHEET NO.	5 OF 11
FILE NO.	A-32255

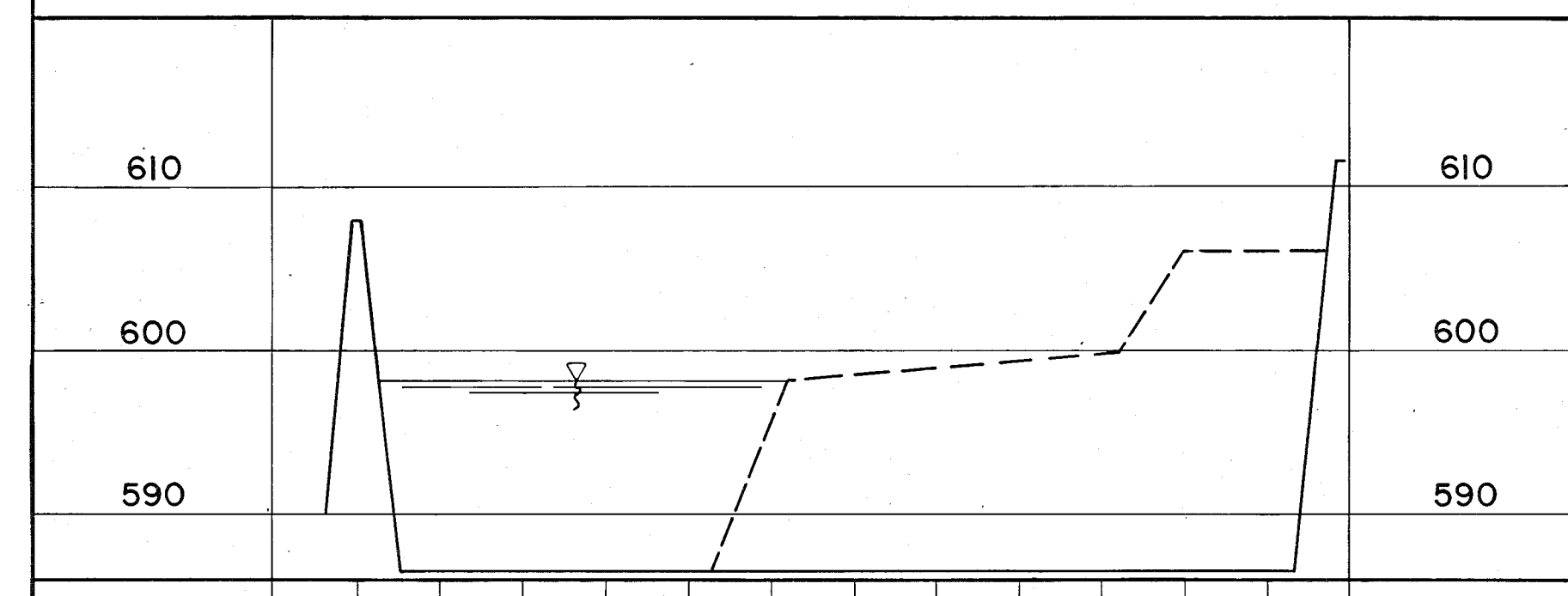
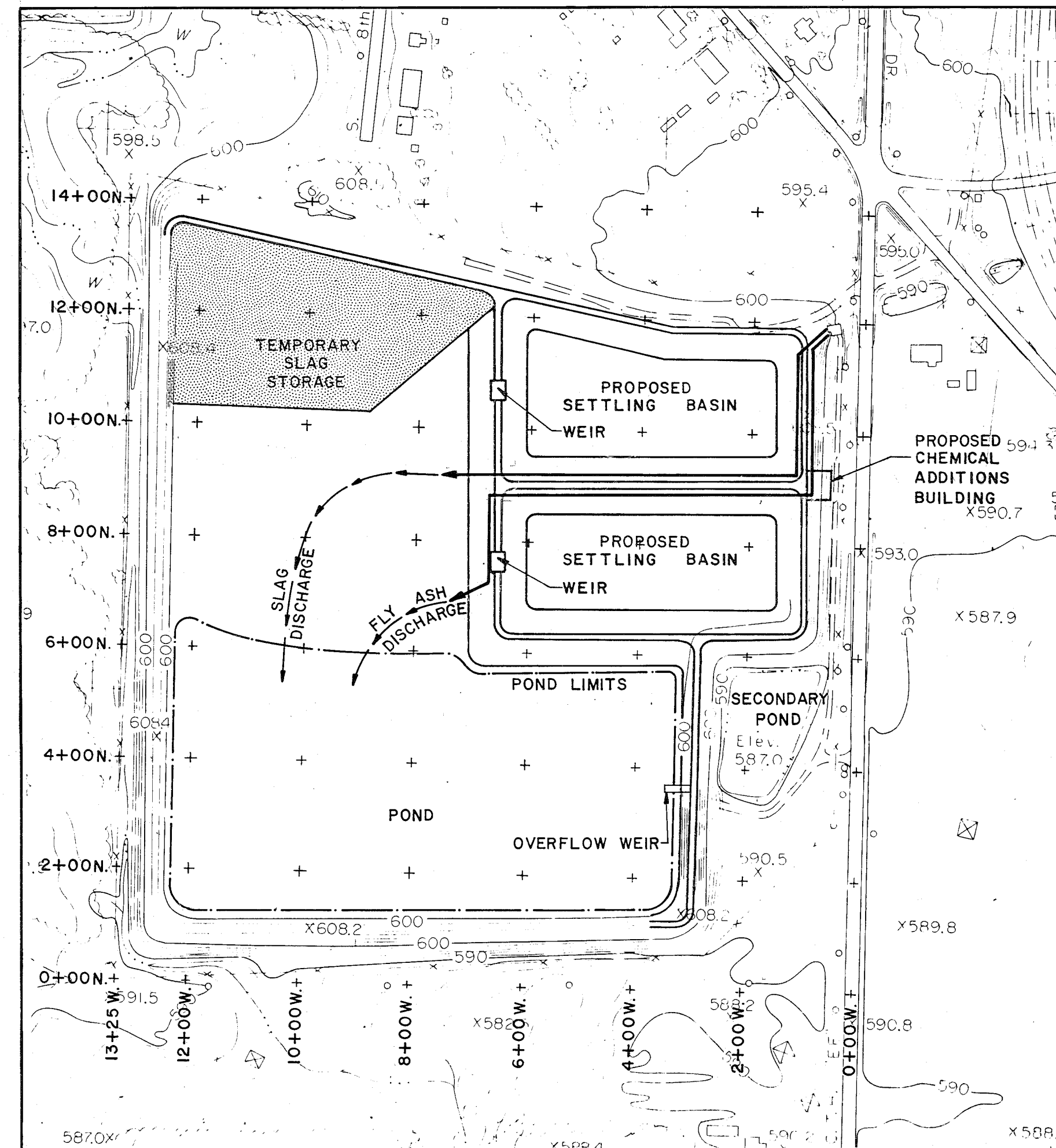

STA. 8+00 W.

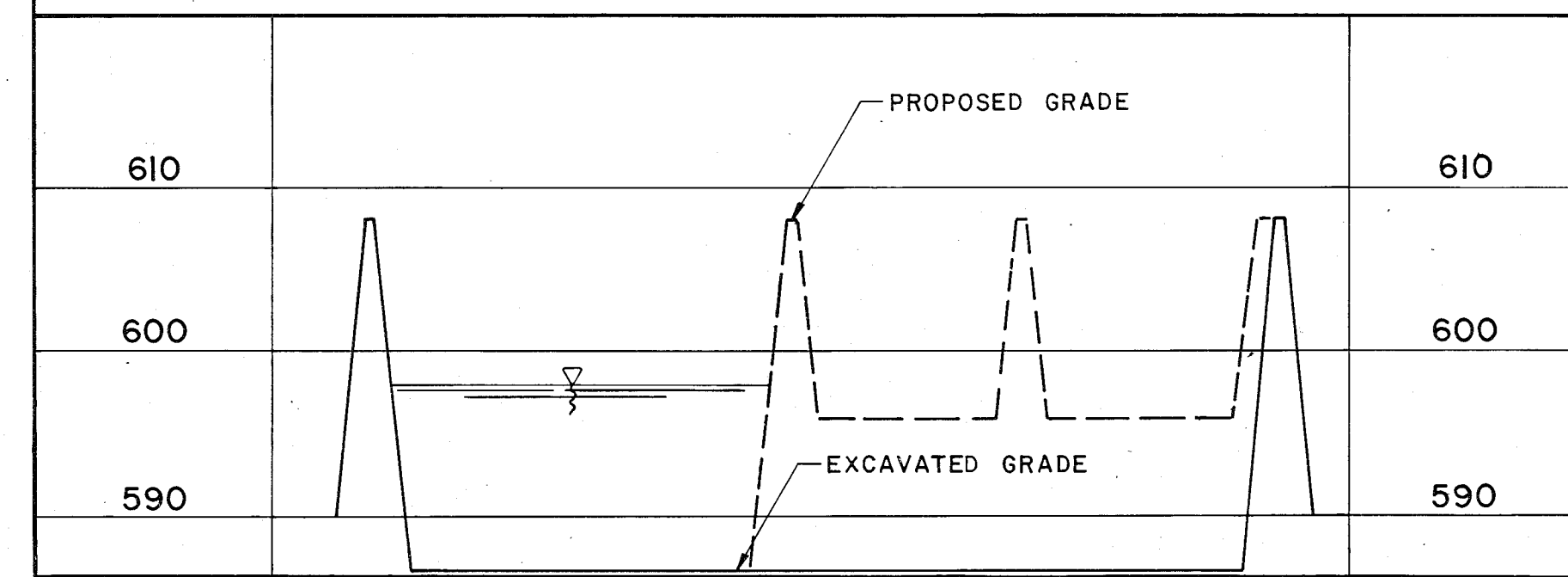

STA. 4+00 W.
PHASE I

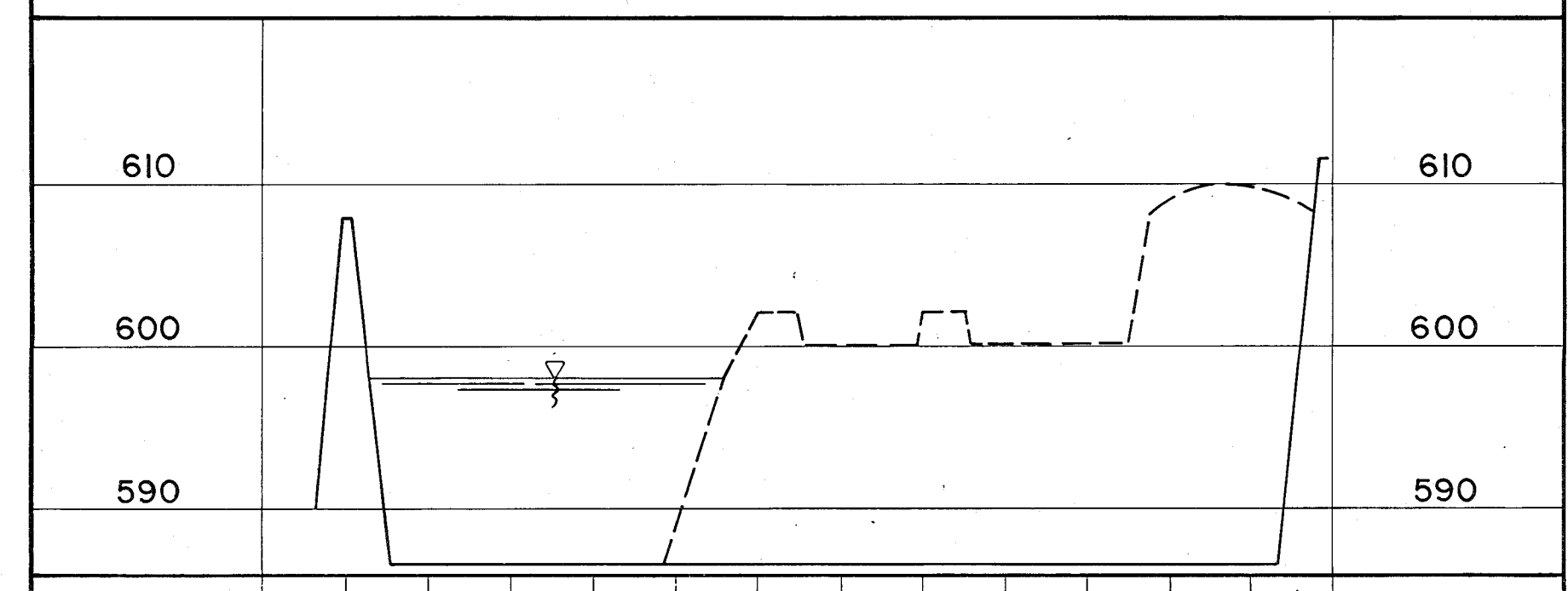
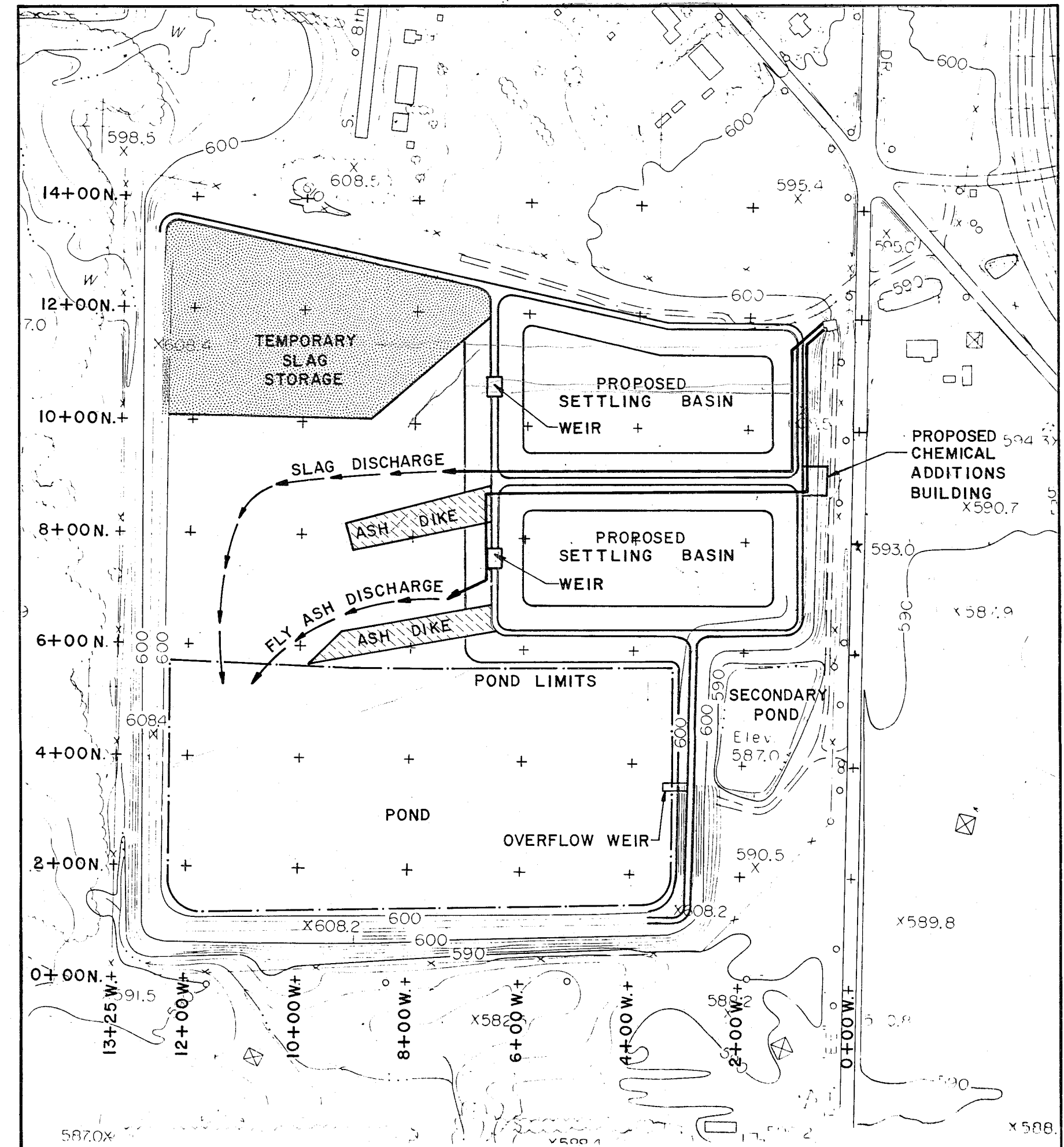

STA. 8+00 W.

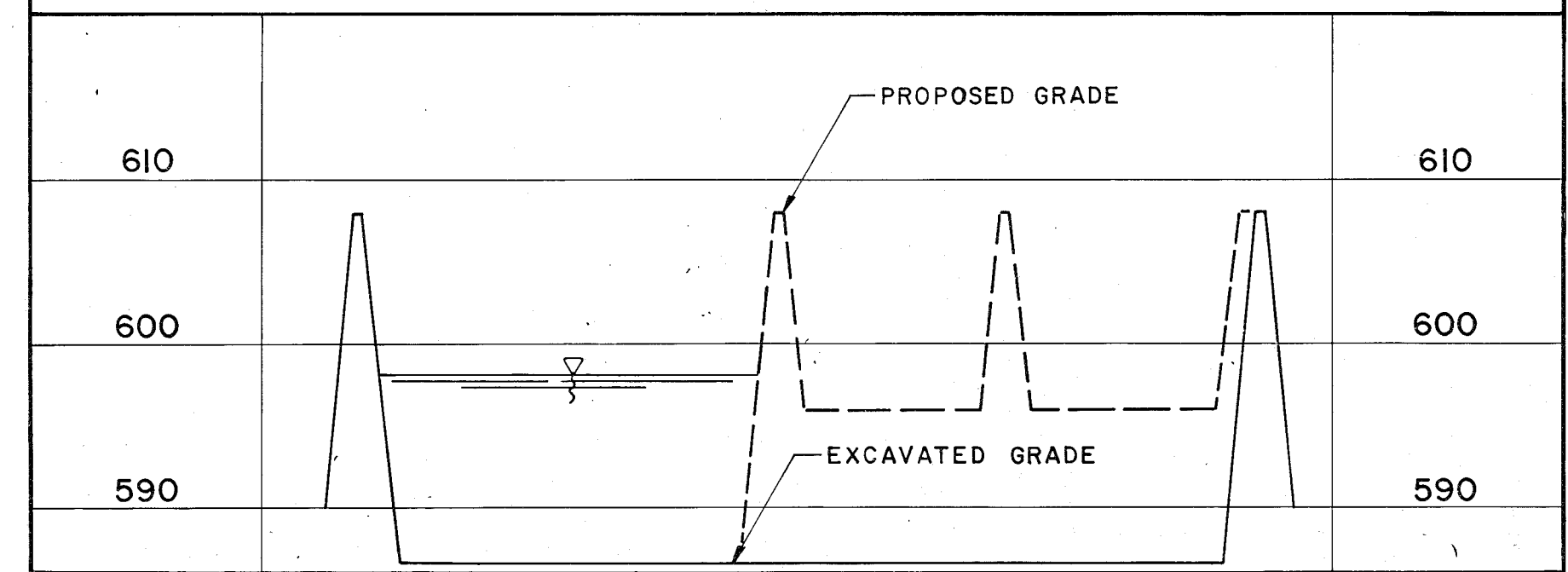

STA. 4+00 W.
PHASE II

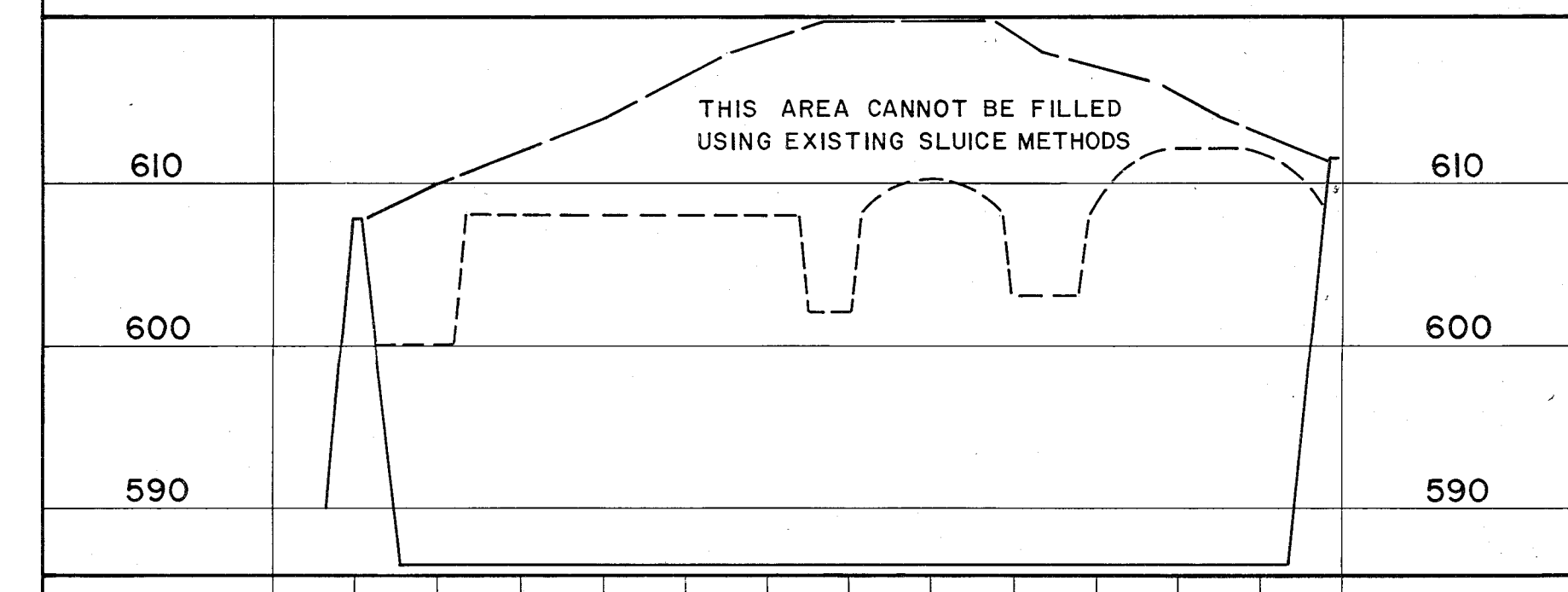
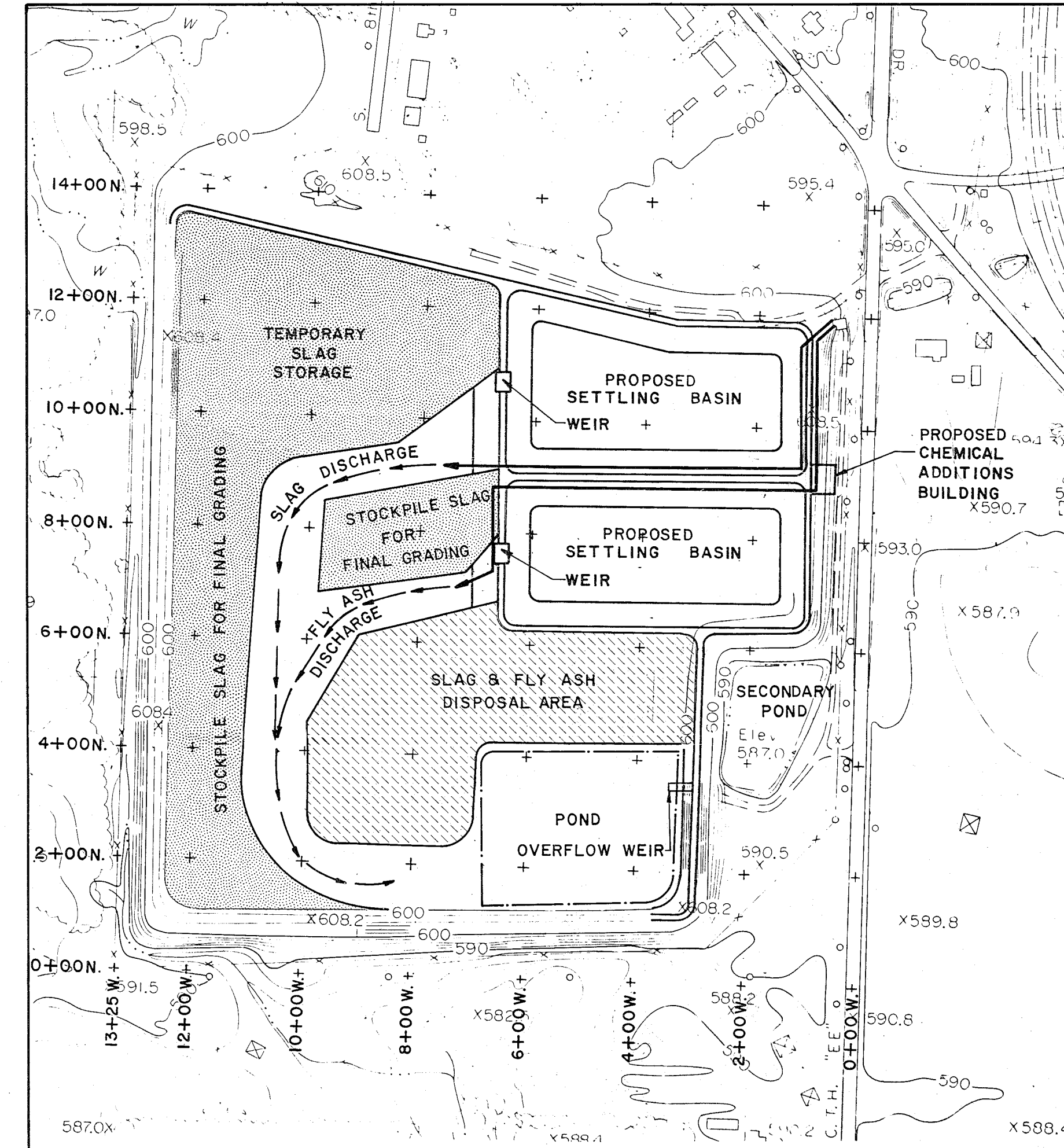

STA. 8+00 W.

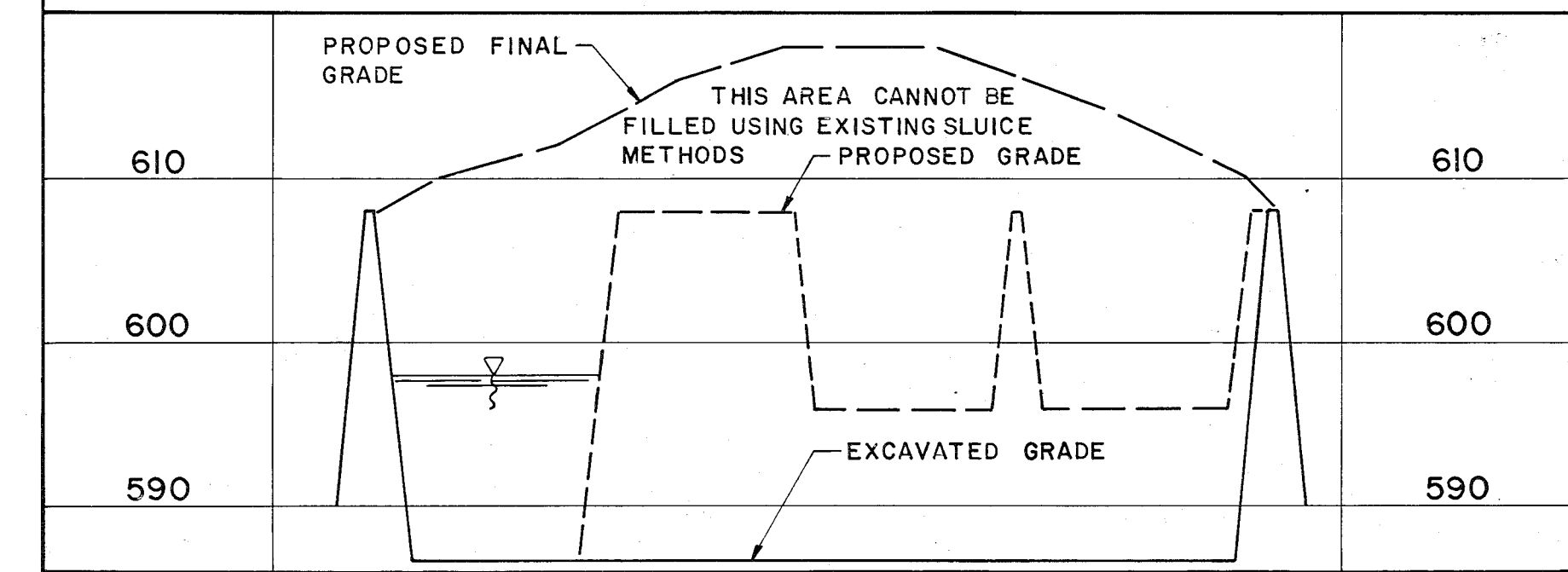

STA. 4+00 W.
PHASE III



DATE APRIL, 1976
 REVISIONS
 DRAWN BY D.K. O'Leary
 CHECKED BY P.C. Kelly
 SCALE 1" = 200'
 HORIZ. 1" = 200'
 VERT. 1" = 10'

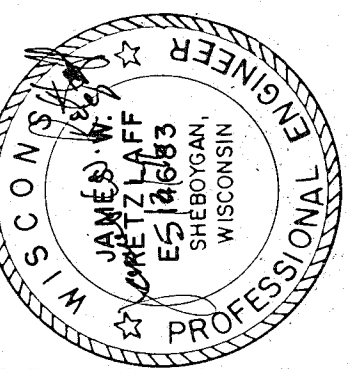

DONOHUE & ASSOCIATES, INC.
 CONSULTING & DESIGN ENGINEERS
 SHEBOYGAN, WISCONSIN

EDGEWATER ASH DISPOSAL SITE
 PROGRESSIVE SITE OPERATION PLAN
 SHEBOYGAN COUNTY, WISCONSIN

PROJECT NO. 4372
 SHEET NO. 6 OF 11
 FILE NO. A-32254



DATE APRIL, 1976
 REVISIONS
 DRAWN BY D.K. Ordway
 CHECKED BY J.W. Rapp
 SCALE 1" = 200'

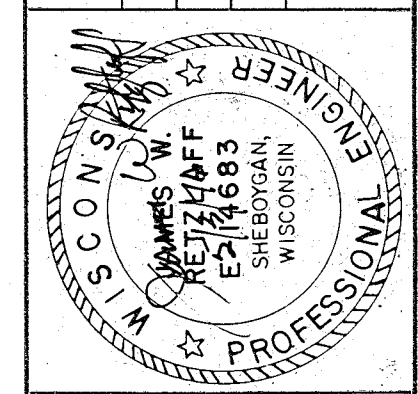

DONOHUE & ASSOCIATES, INC.
 CONSULTING & DESIGN ENGINEERS
 SHEBOYGAN, WISCONSIN

EDGEWATER ASH DISPOSAL SITE
PROPOSED FUTURE DEVELOPMENT PLAN
 SHEBOYGAN COUNTY, WISCONSIN

PROJECT NO. 4372
 SHEET NO. 7 OF 11
 FILE NO. A-32253

DONOHUE & ASSOCIATES, INC. - SHEBOYGAN, WISCONSIN
 DRAFTSMAN: [Signature] CHECKED: [Signature]
 DATE: APRIL, 1976 SCALE: VERT. 1" = 5' HORIZ. 1" = 50' PROJ. No. 4372

FINAL SURVEY
 NOT TO SCALE

ORIGINAL SURVEY
 NOT TO SCALE

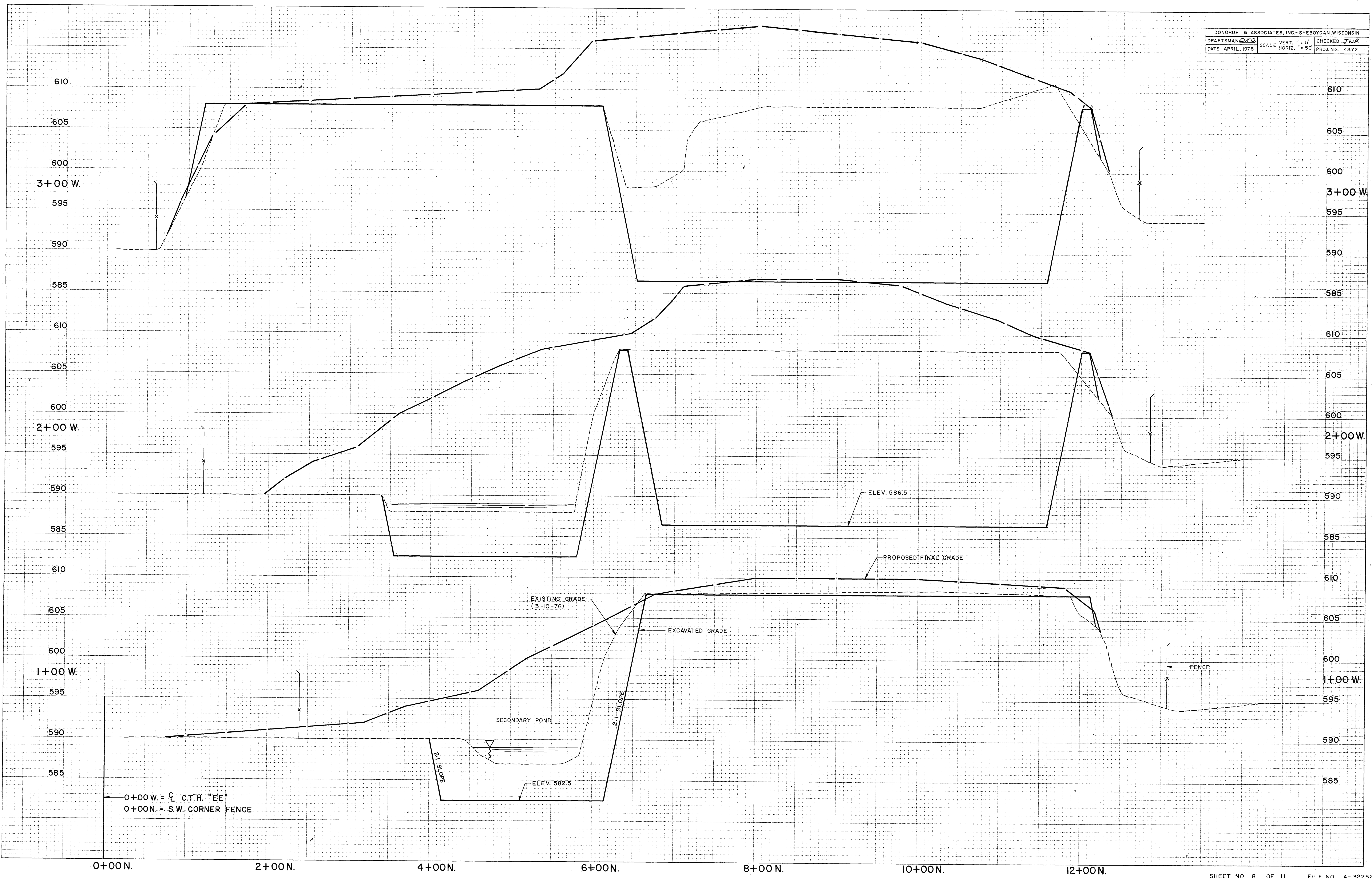

FINAL SURVEY
 NOTE LEGEND
 NO.

ORIGINAL SURVEY
 NOTE BOOK
 NO.

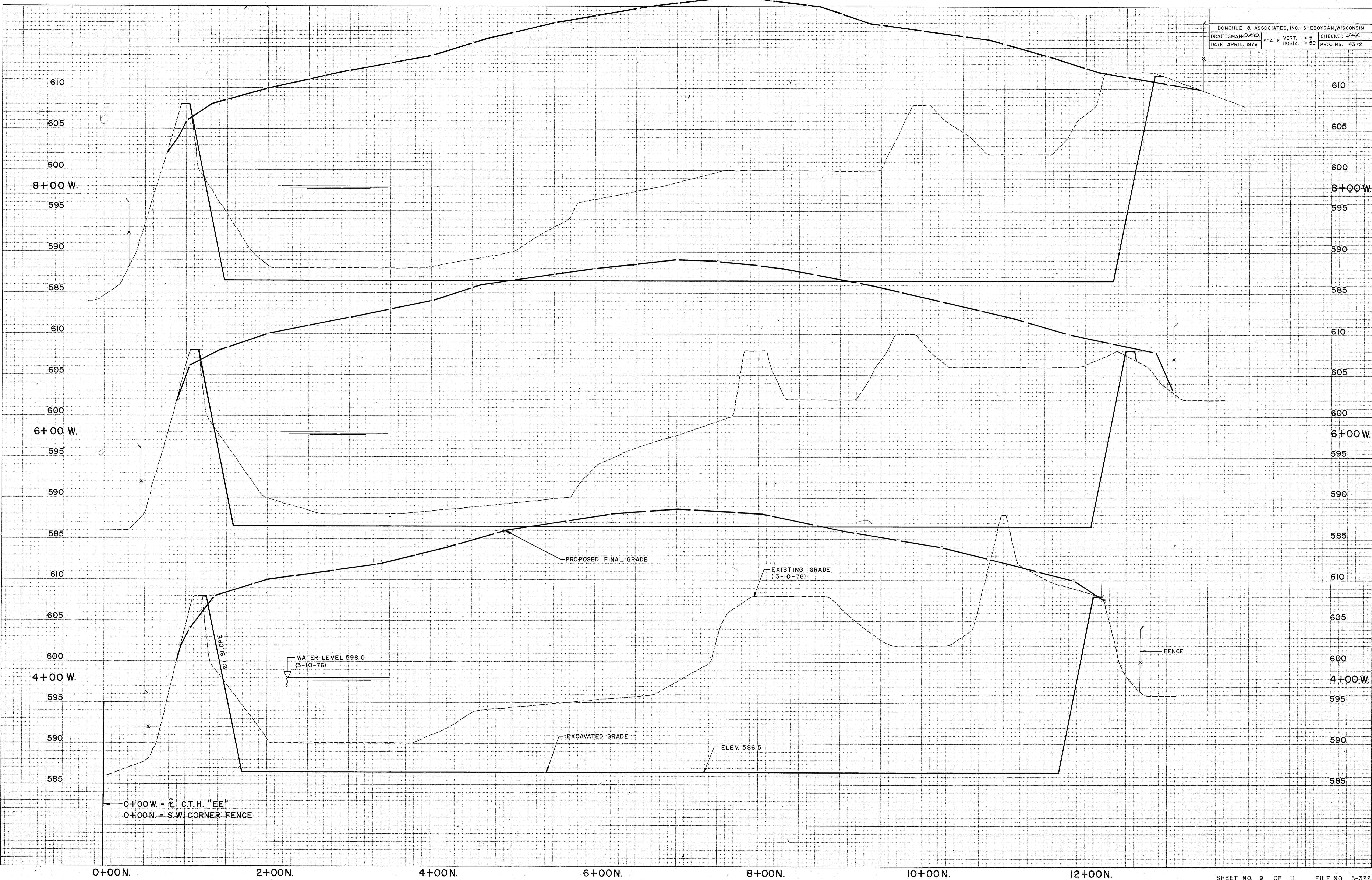

0+00W. = C.T.H. "EE"
 0+00N. = S.W. CORNER FENCE

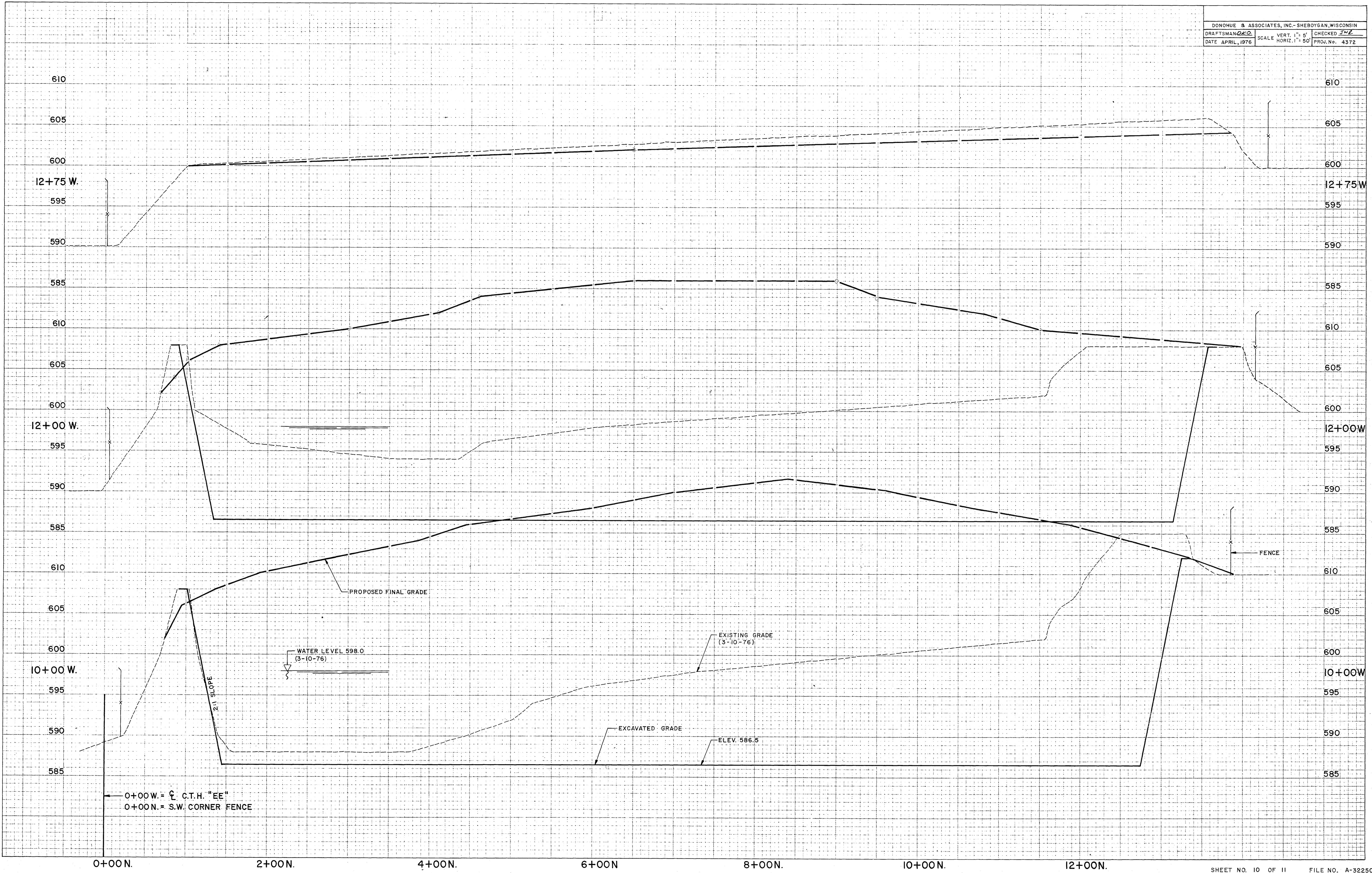

FINAL SURVEY NOTE BOOK NO.

ORIGINAL SURVEY NOTE BOOK NO.

FINAL SURVEY NOTE BOOK NO.

ORIGINAL SURVEY NOTE BOOK NO.

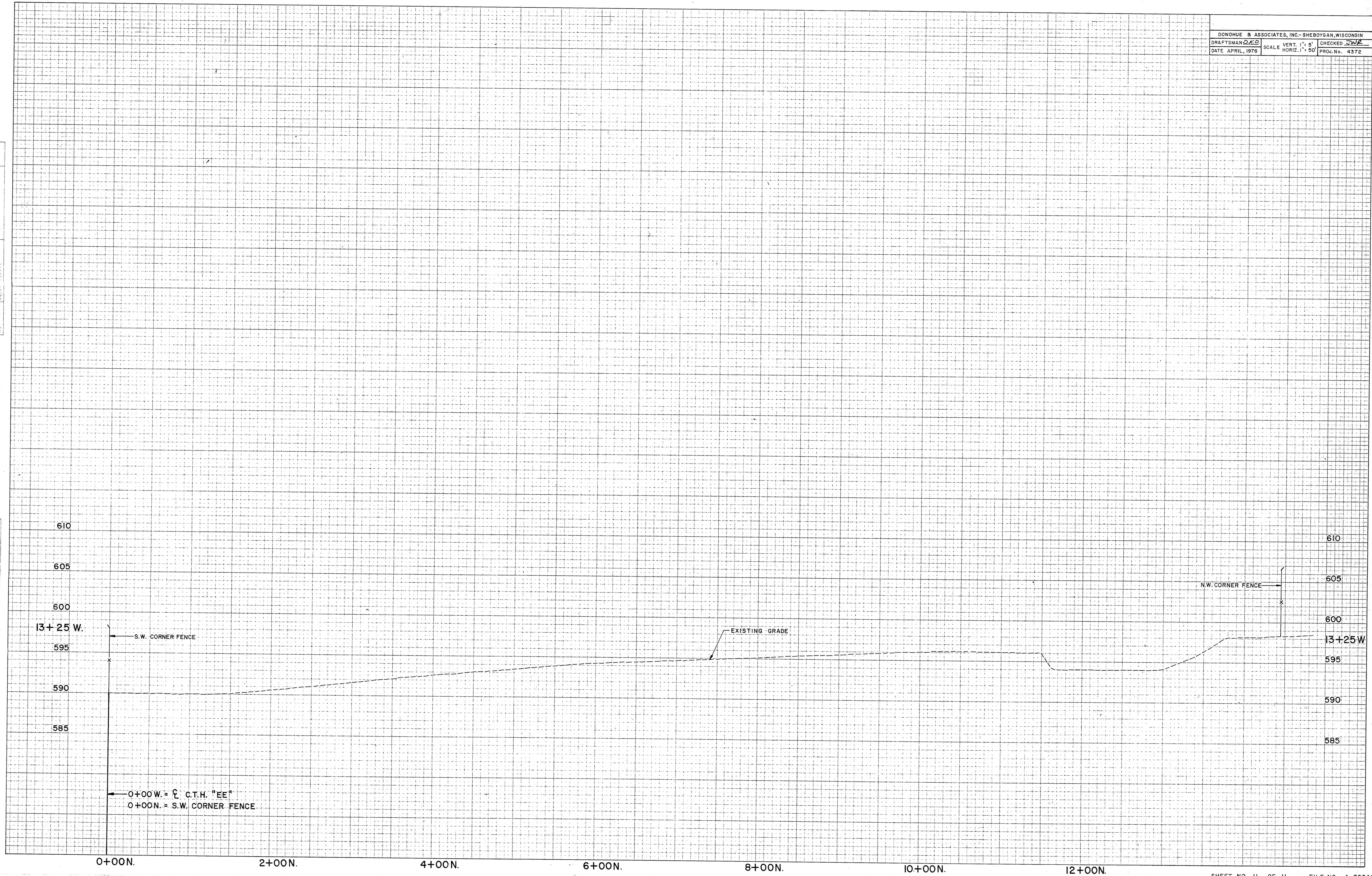

0+00N. 2+00N. 4+00N. 6+00N. 8+00N. 10+00N. 12+00N.

APPENDIX B – EDR Historical Aerial Photograph Package

Alliant Energy
Wisconsin Power and Light Company
Edgewater Generating Station
Sheboygan, Wisconsin

History of Construction





Edgewater Generating Station

3739 Lakeshore Drive
Sheboygan, WI 53081

Inquiry Number: 4555570.10

March 07, 2016

The EDR Aerial Photo Decade Package



6 Armstrong Road, 4th Floor
Shelton, Connecticut 06484
Toll Free: 800.352.0050
www.edrnet.com

EDR Aerial Photo Decade Package

Environmental Data Resources, Inc. (EDR) Aerial Photo Decade Package is a screening tool designed to assist environmental professionals in evaluating potential liability on a target property resulting from past activities. EDR's professional researchers provide digitally reproduced historical aerial photographs, and when available, provide one photo per decade.

When delivered electronically by EDR, the aerial photo images included with this report are for ONE TIME USE ONLY. Further reproduction of these aerial photo images is prohibited without permission from EDR. For more information contact your EDR Account Executive.

Thank you for your business.
Please contact EDR at 1-800-352-0050
with any questions or comments.

Disclaimer - Copyright and Trademark Notice

This Report contains certain information obtained from a variety of public and other sources reasonably available to Environmental Data Resources, Inc. It cannot be concluded from this Report that coverage information for the target and surrounding properties does not exist from other sources. **NO WARRANTY EXPRESSED OR IMPLIED, IS MADE WHATSOEVER IN CONNECTION WITH THIS REPORT. ENVIRONMENTAL DATA RESOURCES, INC. SPECIFICALLY DISCLAIMS THE MAKING OF ANY SUCH WARRANTIES, INCLUDING WITHOUT LIMITATION, MERCHANTABILITY OR FITNESS FOR A PARTICULAR USE OR PURPOSE. ALL RISK IS ASSUMED BY THE USER. IN NO EVENT SHALL ENVIRONMENTAL DATA RESOURCES, INC. BE LIABLE TO ANYONE, WHETHER ARISING OUT OF ERRORS OR OMISSIONS, NEGLIGENCE, ACCIDENT OR ANY OTHER CAUSE, FOR ANY LOSS OF DAMAGE, INCLUDING, WITHOUT LIMITATION, SPECIAL, INCIDENTAL, CONSEQUENTIAL, OR EXEMPLARY DAMAGES. ANY LIABILITY ON THE PART OF ENVIRONMENTAL DATA RESOURCES, INC. IS STRICTLY LIMITED TO A REFUND OF THE AMOUNT PAID FOR THIS REPORT.** Purchaser accepts this Report AS IS. Any analyses, estimates, ratings, environmental risk levels or risk codes provided in this Report are provided for illustrative purposes only, and are not intended to provide, nor should they be interpreted as providing any facts regarding, or prediction or forecast of, any environmental risk for any property. Only a Phase I Environmental Site Assessment performed by an environmental professional can provide information regarding the environmental risk for any property. Additionally, the information provided in this Report is not to be construed as legal advice.

Copyright 2016 by Environmental Data Resources, Inc. All rights reserved. Reproduction in any media or format, in whole or in part, of any report or map of Environmental Data Resources, Inc., or its affiliates, is prohibited without prior written permission.

EDR and its logos (including Sanborn and Sanborn Map) are trademarks of Environmental Data Resources, Inc. or its affiliates. All other trademarks used herein are the property of their respective owners.

Date EDR Searched Historical Sources:

Aerial Photography March 07, 2016

Target Property:

3739 Lakeshore Drive

Sheboygan, WI 53081

<u>Year</u>	<u>Scale</u>	<u>Details</u>	<u>Source</u>
1937	Aerial Photograph. Scale: 1"=500'	Flight Date: August 15, 1937	EDR
1966	Aerial Photograph. Scale: 1"=1000'	Flight Date: October 27, 1966	EDR
1978	Aerial Photograph. Scale: 1"=500'	Flight Date: June 19, 1978	EDR
1981	Aerial Photograph. Scale: 1"=500'	Flight Date: May 06, 1981	EDR
1987	Aerial Photograph. Scale: 1"=500'	Flight Date: June 13, 1987	EDR
1992	Aerial Photograph. Scale: 1"=500'	DOQQ - acquisition dates: May 06, 1992	USGS/DOQQ
1992	Aerial Photograph. Scale: 1"=500'	DOQQ - acquisition dates: May 06, 1992	USGS/DOQQ
2005	Aerial Photograph. Scale: 1"=500'	Flight Year: 2005	USDA/NAIP
2005	Aerial Photograph. Scale: 1"=500'	Flight Year: 2005	USDA/NAIP
2006	Aerial Photograph. Scale: 1"=500'	Flight Year: 2006	USDA/NAIP
2006	Aerial Photograph. Scale: 1"=500'	Flight Year: 2006	USDA/NAIP
2008	Aerial Photograph. Scale: 1"=500'	Flight Year: 2008	USDA/NAIP
2008	Aerial Photograph. Scale: 1"=500'	Flight Year: 2008	USDA/NAIP
2010	Aerial Photograph. Scale: 1"=500'	Flight Year: 2010	USDA/NAIP
2010	Aerial Photograph. Scale: 1"=500'	Flight Year: 2010	USDA/NAIP



INQUIRY #: 455570.10

YEAR: 1937

| = 500'





INQUIRY #: 455570.10

YEAR: 1966

| = 1000'





INQUIRY #: 455570.10

YEAR: 1978

| = 500'





INQUIRY #: 4555570.10

YEAR: 1981

| = 500'





INQUIRY #: 4555570.10

YEAR: 1987

| = 500'





INQUIRY #: 455570.10

YEAR: 1992



— = 500'



INQUIRY #: 455570.10

YEAR: 1992

| = 500'



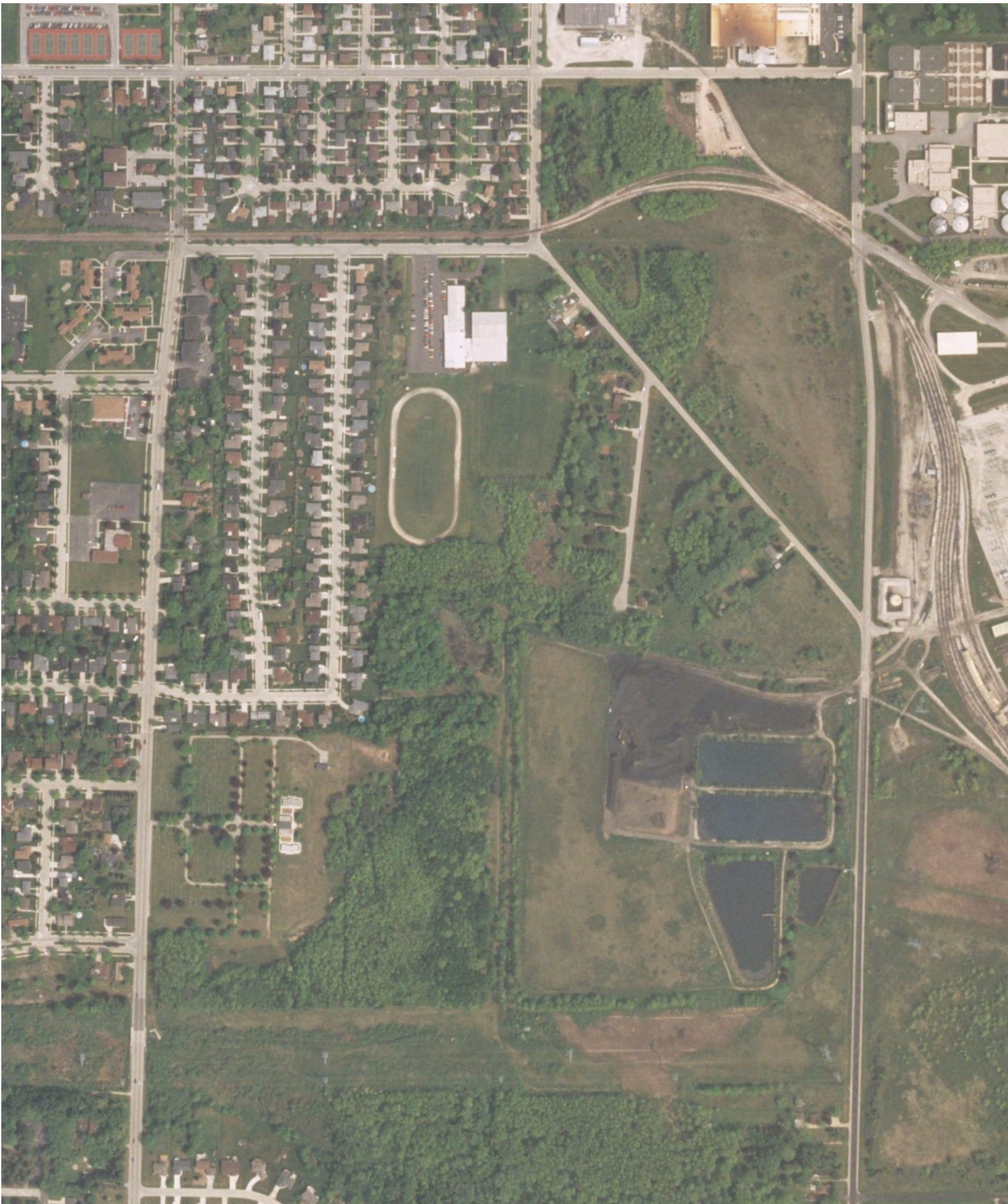

INQUIRY #: 4555570.10

YEAR: 2005

| = 500'





INQUIRY #: 455570.10

YEAR: 2005

| = 500'





INQUIRY #: 455570.10

YEAR: 2006

| = 500'





INQUIRY #: 455570.10

YEAR: 2006

| = 500'



EDR



INQUIRY #: 455570.10

YEAR: 2008

| = 500'





INQUIRY #: 455570.10

YEAR: 2008

| = 500'





INQUIRY #: 455570.10

YEAR: 2010

| = 500'





INQUIRY #: 455570.10

YEAR: 2010

| = 500'



APPENDIX C – EDR Historical Topographic Map Report

Alliant Energy
Wisconsin Power and Light Company
Edgewater Generating Station
Sheboygan, Wisconsin

History of Construction



Edgewater Generating Station
3739 Lakeshore Drive
Sheboygan, WI 53081

Inquiry Number: 4555570.9

March 04, 2016

EDR Historical Topo Map Report

with QuadMatch™



6 Armstrong Road, 4th floor
Shelton, CT 06484
Toll Free: 800.352.0050
www.edrnet.com

Site Name: Edgewater Generating Station 3739 Lakeshore Drive Sheboygan, WI 53081 EDR Inquiry # 4555570.9	Client Name: Environmental Site Assessors 932 North Wright Street, Suite 100 Naperville, IL 60563 Contact: Mark W Loerop
---	---



EDR Topographic Map Library has been searched by EDR and maps covering the target property location as provided by Environmental Site Assessors were identified for the years listed below. EDR's Historical Topo Map Report is designed to assist professionals in evaluating potential liability on a target property resulting from past activities. EDR's Historical Topo Map Report includes a search of a collection of public and private color historical topographic maps, dating back to the late 1800s.

Search Results:

Coordinates:

Site Name:	Edgewater Generating Station	Latitude:	43.714887 43° 42' 54" North
Address:	3739 Lakeshore Drive	Longitude:	-87.707224 -87° 42' 26" West
City,State,Zip:	Sheboygan, WI 53081	UTM Zone:	Zone 16 North
P.O.#	154.018.012.006	UTM X Meters:	443028.06
Project:	EDG Historical Docs	UTM Y Meters:	4840449.76
		Elevation:	596.01' above sea level

Maps Provided:

- 2013
- 1994
- 1973
- 1954

Disclaimer - Copyright and Trademark Notice

This Report contains certain information obtained from a variety of public and other sources reasonably available to Environmental Data Resources, Inc. It cannot be concluded from this Report that coverage information for the target and surrounding properties does not exist from other sources. NO WARRANTY EXPRESSED OR IMPLIED, IS MADE WHATSOEVER IN CONNECTION WITH THIS REPORT. ENVIRONMENTAL DATA RESOURCES, INC. SPECIFICALLY DISCLAIMS THE MAKING OF ANY SUCH WARRANTIES, INCLUDING WITHOUT LIMITATION, MERCHANTABILITY OR FITNESS FOR A PARTICULAR USE OR PURPOSE. ALL RISK IS ASSUMED BY THE USER. IN NO EVENT SHALL ENVIRONMENTAL DATA RESOURCES, INC. BE LIABLE TO ANYONE, WHETHER ARISING OUT OF ERRORS OR OMISSIONS, NEGLIGENCE, ACCIDENT OR ANY OTHER CAUSE, FOR ANY LOSS OF DAMAGE, INCLUDING, WITHOUT LIMITATION, SPECIAL, INCIDENTAL, CONSEQUENTIAL, OR EXEMPLARY DAMAGES. ANY LIABILITY ON THE PART OF ENVIRONMENTAL DATA RESOURCES, INC. IS STRICTLY LIMITED TO A REFUND OF THE AMOUNT PAID FOR THIS REPORT. Purchaser accepts this Report "AS IS". Any analyses, estimates, ratings, environmental risk levels or risk codes provided in this Report are provided for illustrative purposes only, and are not intended to provide, nor should they be interpreted as providing any facts regarding, or prediction or forecast of, any environmental risk for any property. Only a Phase I Environmental Site Assessment performed by an environmental professional can provide information regarding the environmental risk for any property. Additionally, the information provided in this Report is not to be construed as legal advice.

Copyright 2016 by Environmental Data Resources, Inc. All rights reserved. Reproduction in any media or format, in whole or in part, of any report or map of Environmental Data Resources, Inc., or its affiliates, is prohibited without prior written permission.

EDR and its logos (including Sanborn and Sanborn Map) are trademarks of Environmental Data Resources, Inc. or its affiliates. All other trademarks used herein are the property of their respective owners.

Topo Sheet Thumbnails

This EDR Topo Map Report is based upon the following USGS topographic map sheets.

2013 Source Sheets



Sheboygan South
2013
7.5-minute, 24000

1994 Source Sheets



Sheboygan South
1994
7.5-minute, 24000
Photo Revised 1994
Aerial Photo Revised 1992

1973 Source Sheets



Sheboygan South
1973
7.5-minute, 24000
Photo Revised 1973
Aerial Photo Revised 1973

1954 Source Sheets

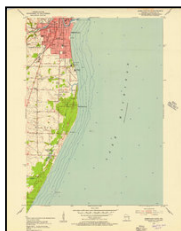

Sheboygan South
1954
7.5-minute, 24000
Aerial Photo Revised 1952

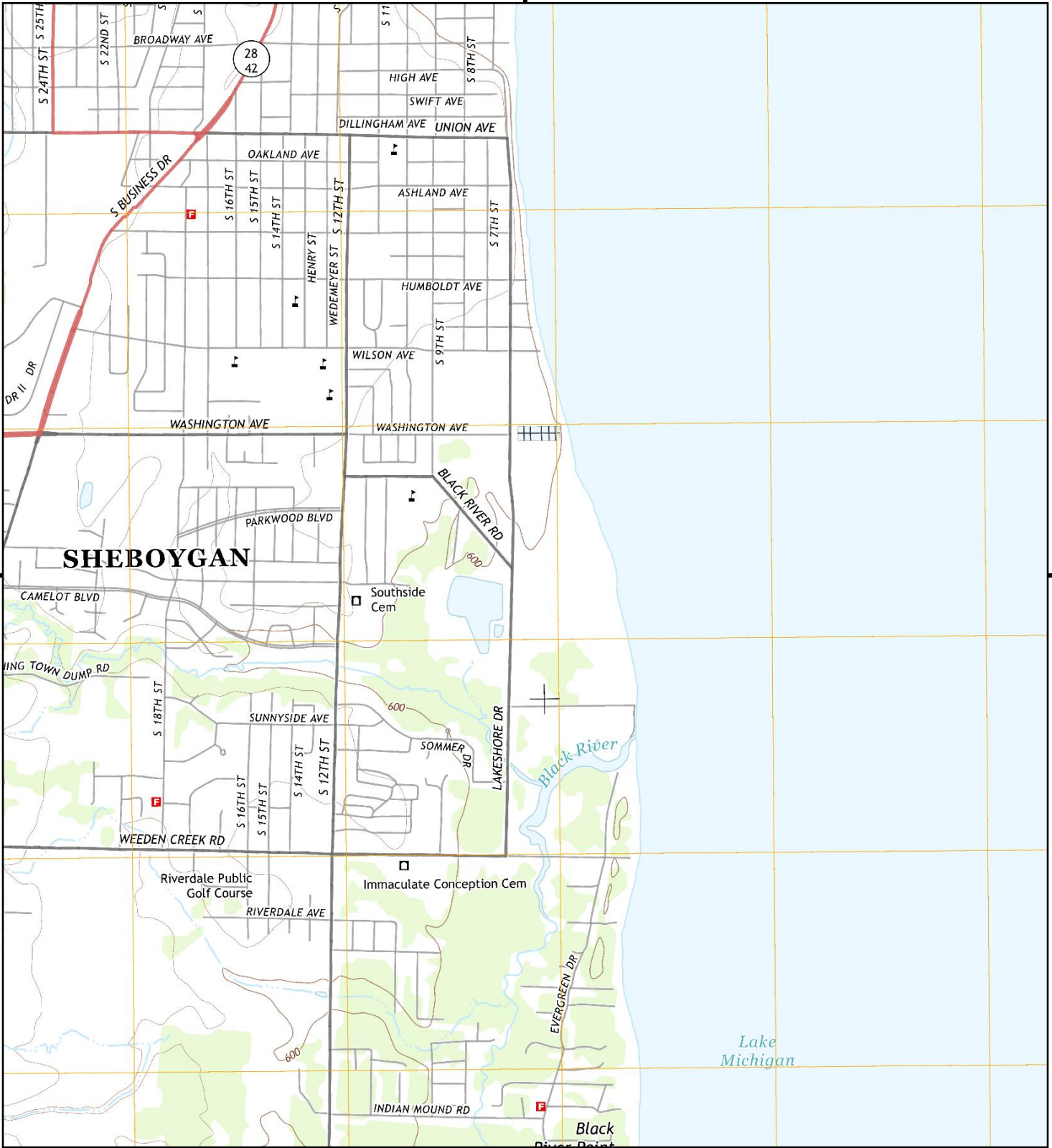

This report includes information from the following map sheet(s).

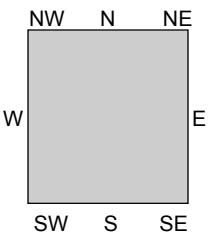
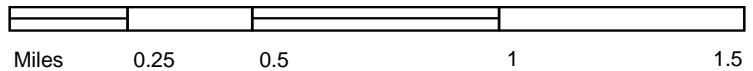

TP, Sheboygan South, 2013, 7.5-minute

SITE NAME: Edgewater Generating Station
 ADDRESS: 3739 Lakeshore Drive
 Sheboygan, WI 53081
 CLIENT: Environmental Site Assessors



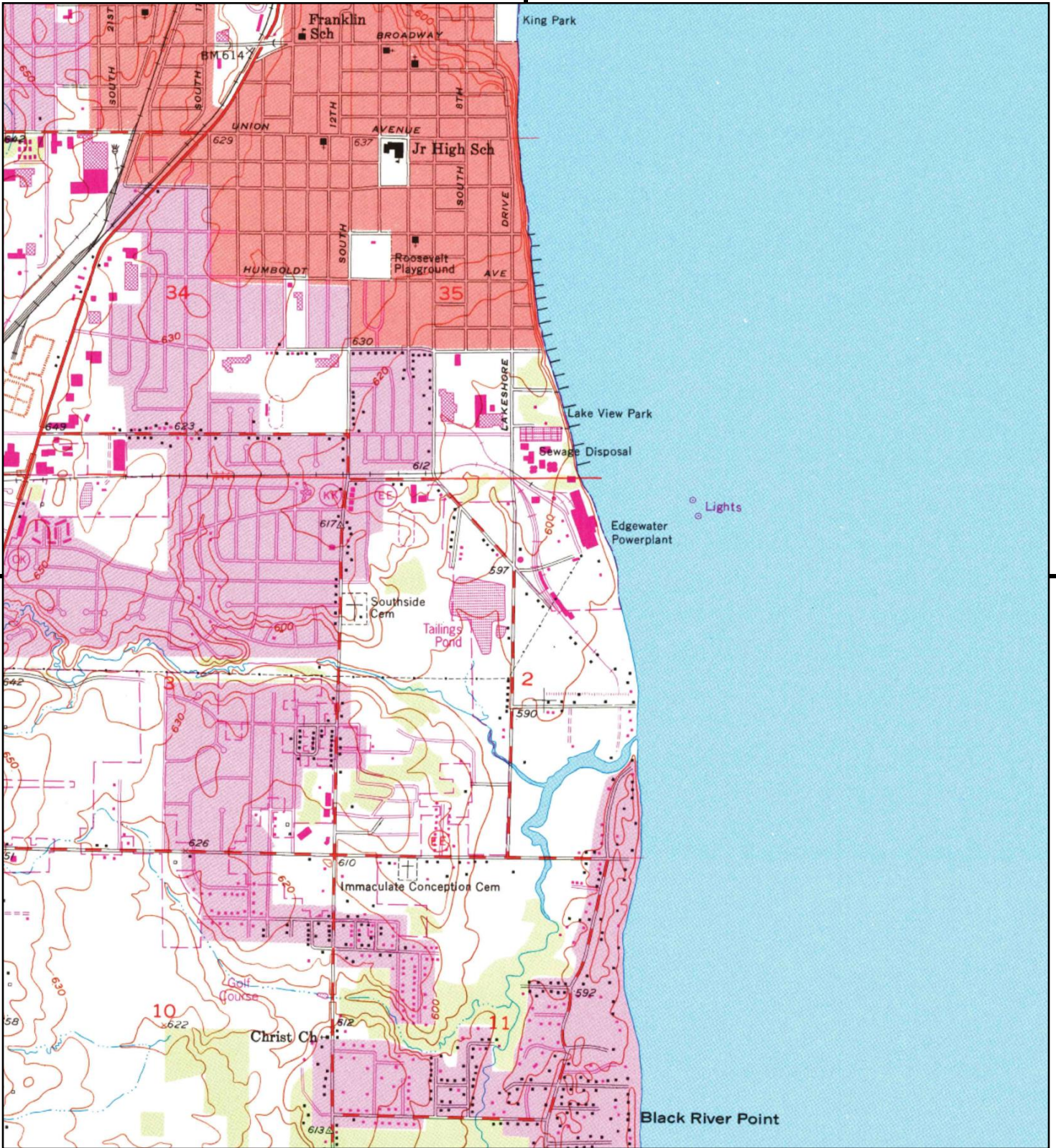

This report includes information from the following map sheet(s).

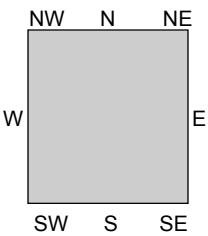
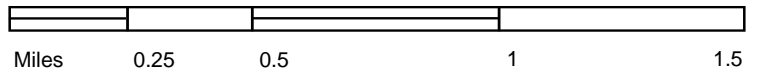

TP, Sheboygan South, 1994, 7.5-minute

SITE NAME: Edgewater Generating Station
 ADDRESS: 3739 Lakeshore Drive
 Sheboygan, WI 53081
 CLIENT: Environmental Site Assessors



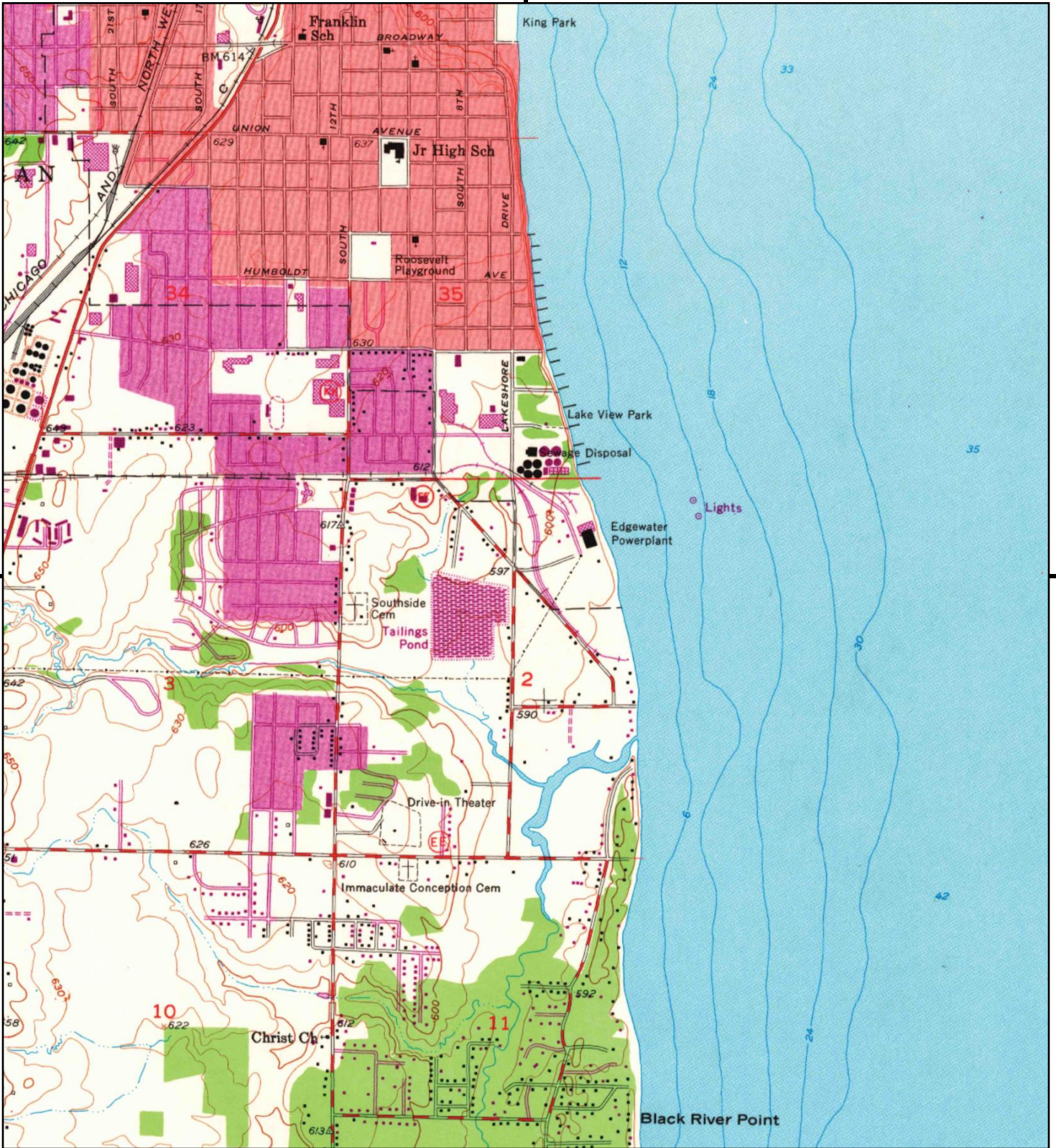

This report includes information from the following map sheet(s).

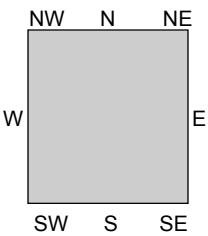
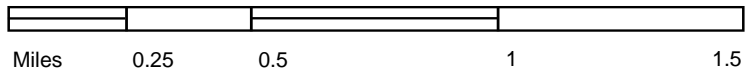

TP, Sheboygan South, 1973, 7.5-minute

SITE NAME: Edgewater Generating Station
 ADDRESS: 3739 Lakeshore Drive
 Sheboygan, WI 53081
 CLIENT: Environmental Site Assessors



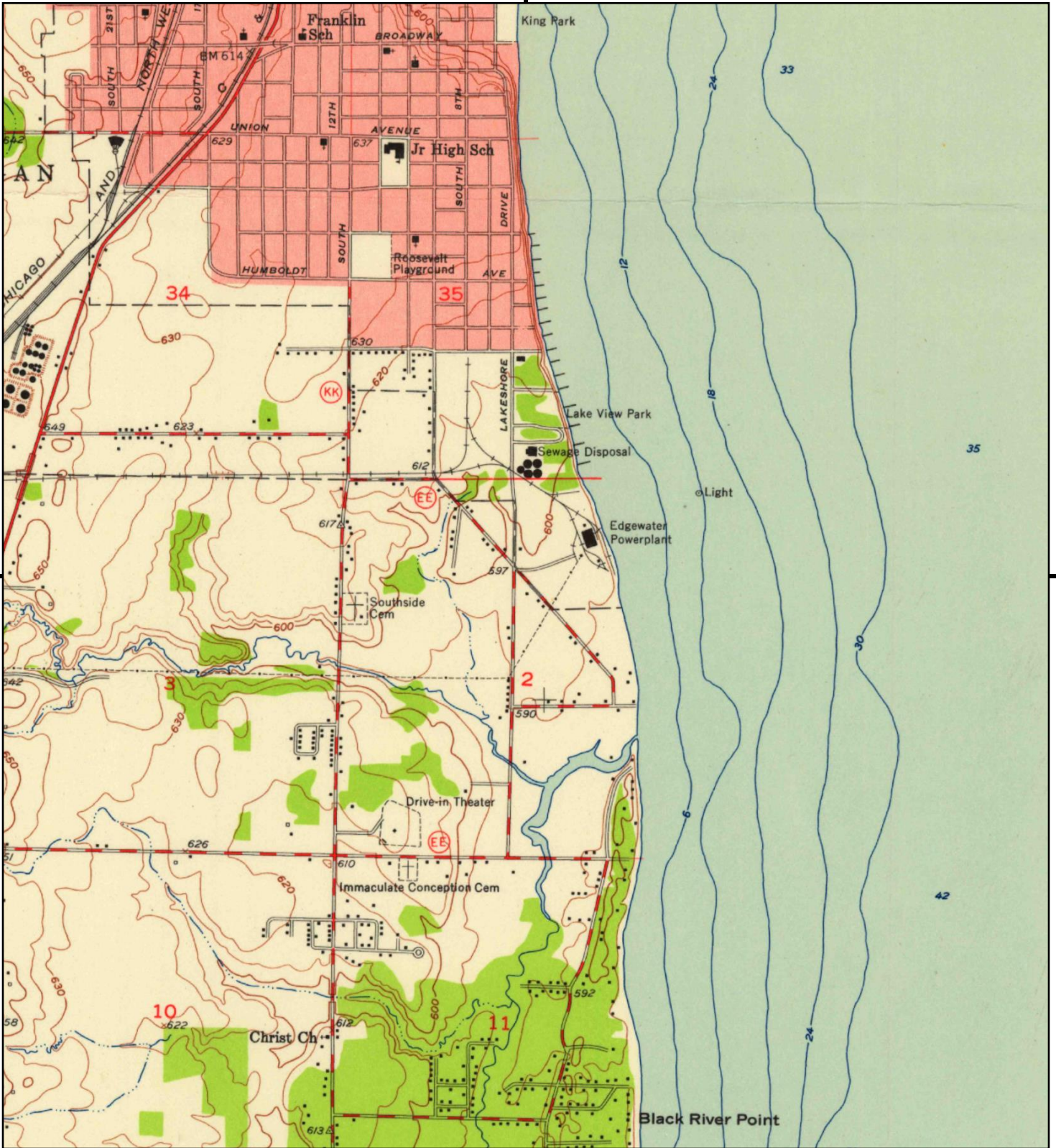

This report includes information from the following map sheet(s).

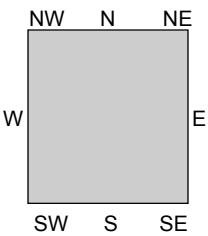
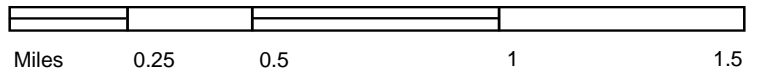

TP, Sheboygan South, 1954, 7.5-minute

SITE NAME: Edgewater Generating Station
 ADDRESS: 3739 Lakeshore Drive
 Sheboygan, WI 53081
 CLIENT: Environmental Site Assessors



**APPENDIX D – Geoprobe Soil Borings -
2011**

Alliant Energy
Wisconsin Power and Light Company
Edgewater Generating Station
Sheboygan, Wisconsin

History of Construction



LEGEND

A
589.5

MILLER ENGINEERS & SCIENTISTS JANUARY AND FEBRUARY 2011 SOIL EXPLORATION BORINGS & GROUND ELEVATION MEASUREMENTS

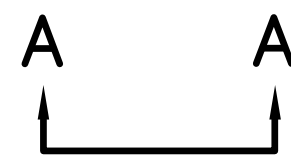

BERM CROSS SECTION LOCATION

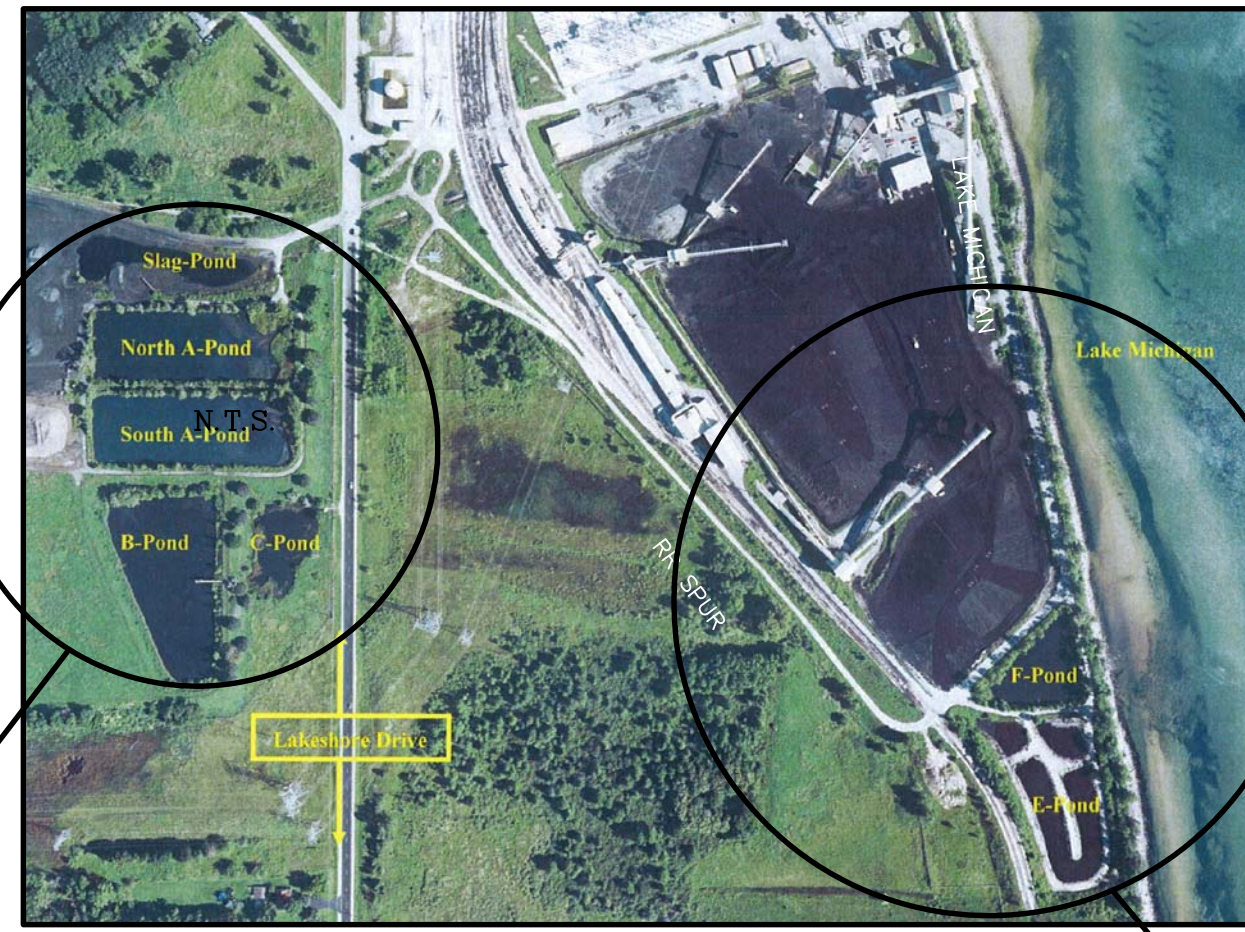

SITE LOCATION MAP

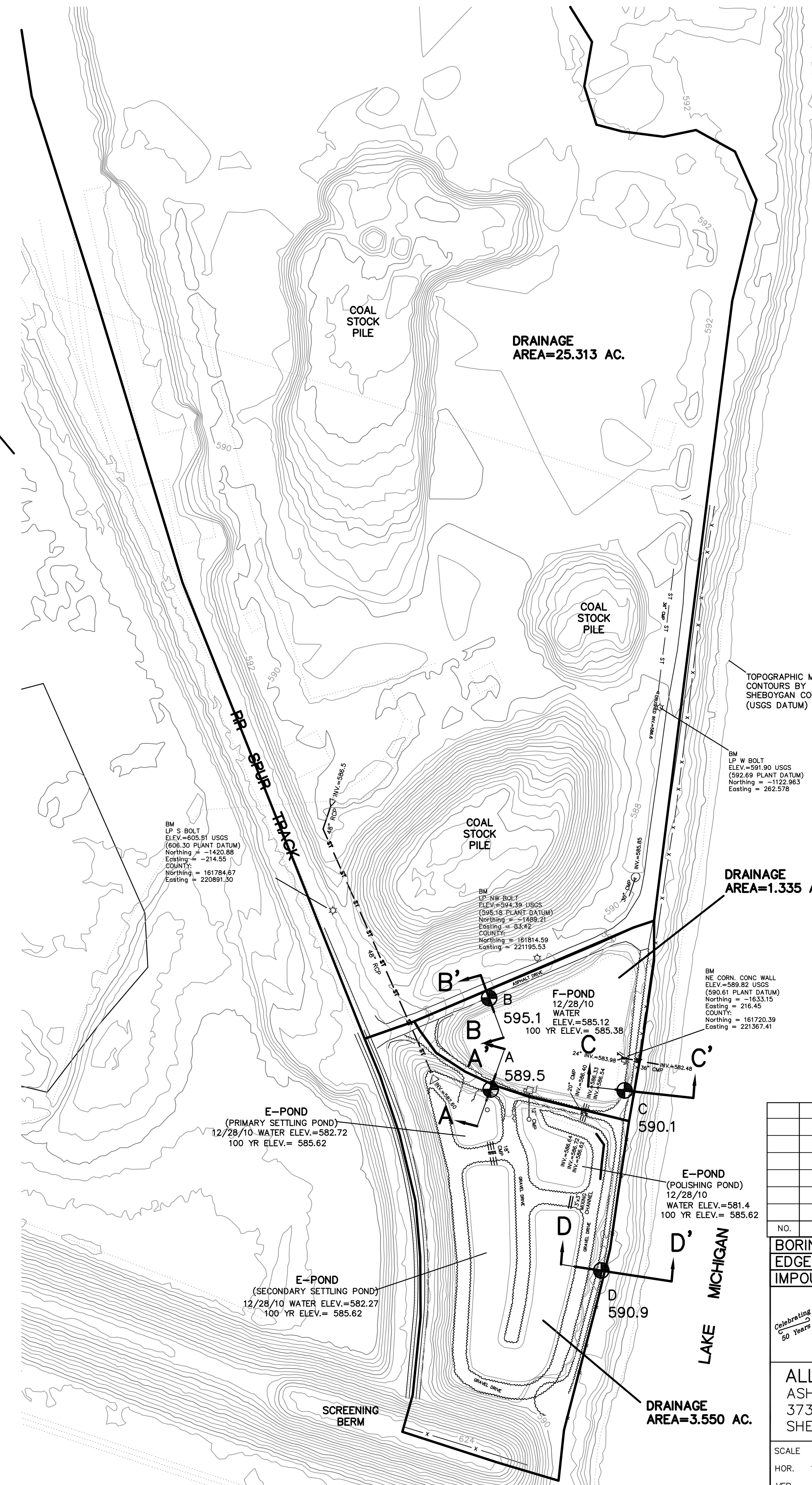
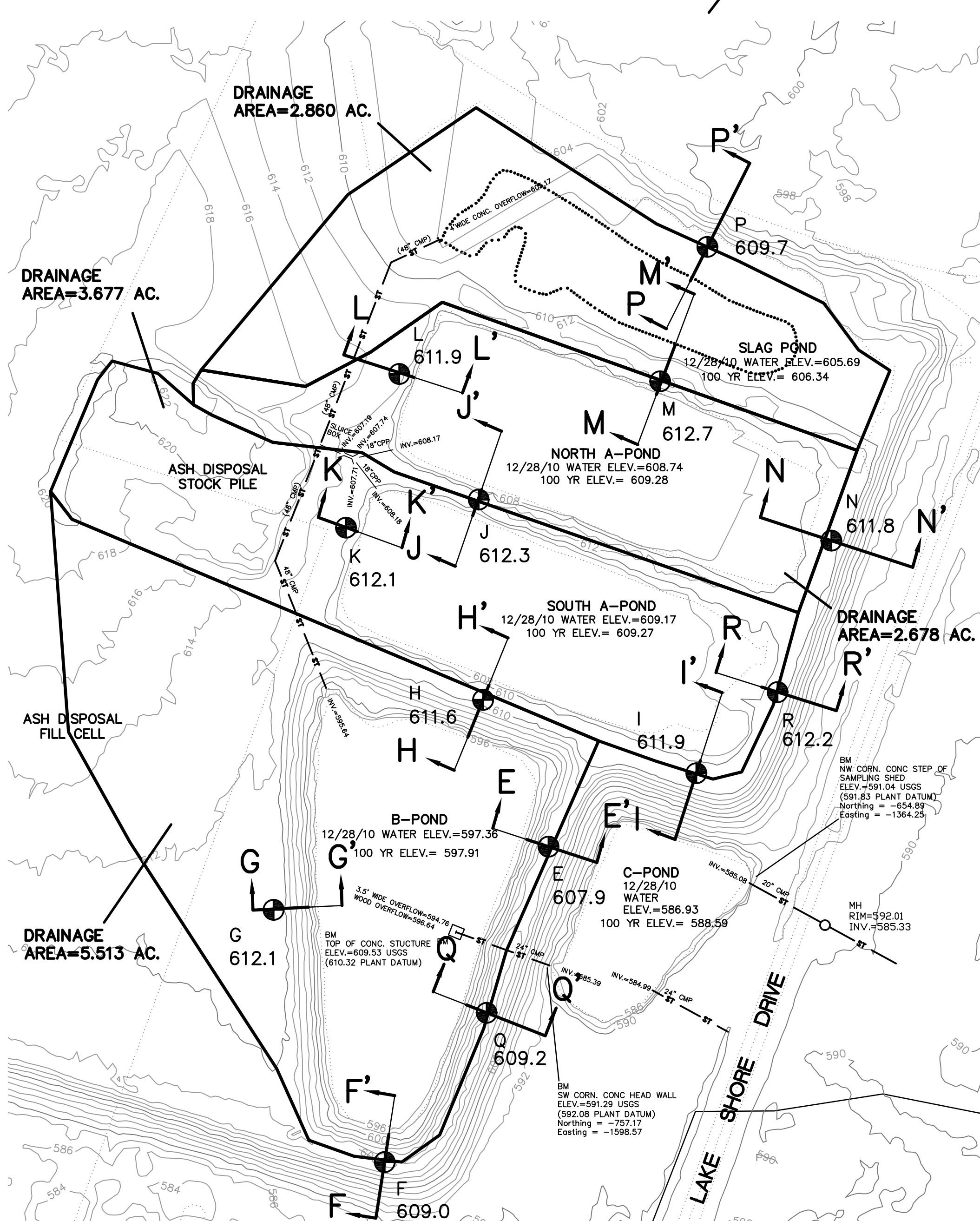
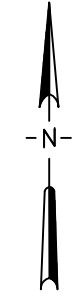

LAKE MICHIGAN

CALM WATER LEVEL 2/2011=578.0 ft
HISTORIC HIGH (1986)= 582.9 ft
HISTORIC LOW (1964)= 576.6 ft
HISTORIC AVERAGE= 579.5 ft

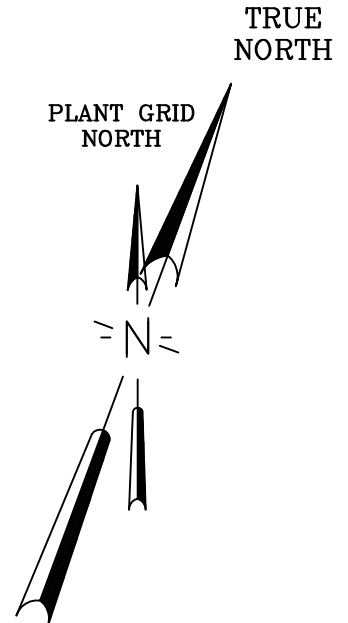

GRAPHIC SCALE
(IN FEET)
1 inch = 100 ft.

ELEVATIONS IN NGVD DATUM
UNLESS NOTED OTHERWISE
PLANT DATUM= NGVD+ 0.79'

NO.	DATE	DESCRIPTION	BY
BORING & CROSS SECTION LOCATION PLAN			
EDGEWATER GENERATING STATION			
IMPOUNDMENT ANALYSIS			
		5308 S. 12th Street Sheboygan, WI 53081-8099 Phone 920-458-6164 Fax 920-458-0369 www.StartWithMiller.com	
ALLIANT ENERGY ASH POND SLOPE STABILITY EVALUATION 3739 LAKE SHORE DRIVE SHEBOYGAN, WISCONSIN			
SCALE	DATE	BY	SHEET
HOR. 1"=100'	FEB. 25, 2011	WGF	1
VER. 1"=XXX	JOB	CK	5
	10-18634-C	RGM	OF

CLASSIFICATION OF SOILS FOR ENGINEERING PURPOSES

ASTM Designation: D 2487 – 69 AND D 2488 – 69

(Unified Soil Classification System)

Major divisions		Group symbols	Typical names	Classification criteria		
Coarse-grained soils More than 50% retained on No. 200 sieve*	Gravels 50% or more of coarse fraction retained on No. 4 sieve	Clean gravels	GW	Well-graded gravels and gravel-sand mixtures, little or no fines	$C_u = \frac{D_{60}}{D_{10}}$ greater than 4; $C_z = \frac{(D_{30})^2}{D_{10} \times D_{60}}$ between 1 and 3	
		Gravels with fines	GP	Poorly graded gravels and gravel-sand mixtures, little or no fines		Not meeting both criteria for GW
		Gravels with fines	GM	Silty gravels, gravel-sand-silt mixtures	Atterberg limits below "A" line or P.I. less than 4	Atterberg limits plotting in hatched area are <i>borderline</i> classifications requiring use of dual symbols
			GC	Clayey gravels, gravel-sand-clay mixtures		
	Sands More than 50% of coarse fraction passes No. 4 sieve	Clean sands	SW	Well-graded sands and gravelly sands, little or no fines	$C_u = \frac{D_{60}}{D_{10}}$ greater than 6; $C_z = \frac{(D_{30})^2}{D_{10} \times D_{60}}$ between 1 and 3	
			SP	Poorly graded sands and gravelly sands, little or no fines		Not meeting both criteria for SW
		Sands with fines	SM	Silty sands, sand-silt mixtures	Atterberg limits below "A" line or P.I. less than 4	Atterberg limits plotting in hatched area are <i>borderline</i> classifications requiring use of dual symbols
			SC	Clayey sands, sand-clay mixtures		
					Classification on basis of percentage of fines Less than 5% pass No. 200 sieve GW, GP, SW, SP More than 12% pass No. 200 sieve GM, GC, SM, SC 5 to 12% pass No. 200 sieve <i>Borderline</i> classifications requiring use of dual symbols	
Fine-grained soils 50% or more passes No. 200 sieve*	Silts and clays Liquid limit 50% or less	ML	Inorganic silts, very fine sands, rock flour, silty or clayey fine sands	Plasticity Chart For classification of fine-grained soils and fine fraction of coarse-grained soils. Atterberg Limits plotting in hatched area are <i>borderline</i> classifications requiring use of dual symbols. Equation of A-line: $PI = 0.73 (LL - 20)$		
		CL	Inorganic clays of low to medium plasticity, gravelly clays, sandy clays, silty clays, lean clays			
		OL	Organic silts and organic silty clays of low plasticity			
	Silts and clays Liquid limit greater than 50%	MH	Inorganic silts, micaceous or diatomaceous fine sands or silts, elastic silts		OH and MH	
		CH	Inorganic clays of high plasticity, fat clays		CH	
		OH	Organic clays of medium to high plasticity, organic silts		OH and MH	
	Highly organic soils	Pt	Peat, muck and other highly organic soils		ML and OL	

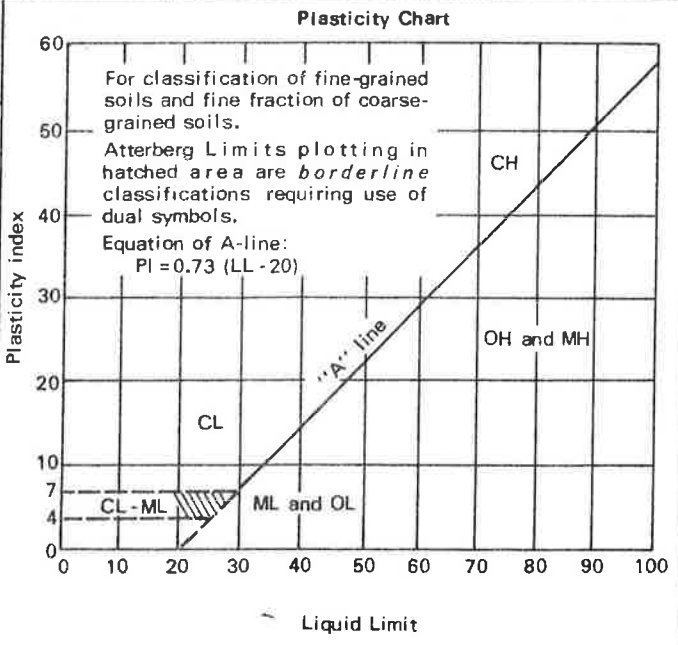

*Based on the material passing the 3 in. (76 mm) sieve.

LOG OF TEST BORING GENERAL NOTES

SYMBOLS

Descriptive Soil Classification

GRAIN SIZE TERMINOLOGY

Soil Fraction	Particle Size	U.S. Sieve Size
Boulders.....	Larger Than 12".....	Larger Than 12"
Cobbles.....	3" to 12".....	3" to 12"
Gravel: Coarse.....	3/4" to 3".....	3/4" to 3"
Fine.....	4.76mm to 3/4".....	#4 to 3/4"
Sand: Coarse.....	2.00mm to 4.76mm.....	#10 to #4
Medium.....	0.42mm to 2.00mm.....	#40 to #10
Fine.....	0.074mm to 0.42mm.....	#200 to #40
Fines.....	Less Than 0.074mm.....	Smaller Than #200
Silt.....	0.005mm to 0.074mm.....	Smaller Than #200
Clay.....	Smaller Than 0.005mm	

(Plasticity characteristics differentiate between silt and clay.)

COMPOSITION TERMINOLOGY (ASTM D2487)

Primary Constituent:

Gravel

with sand...>=15% sand
with silt.....5-12% silt
with clay.....5-12% clay
silty.....>12% silt
clayey.....>12% clay

Sand

with gravel.....>=15% gravel
with silt.....5-12% silt
with clay.....5-12% clay
silty.....>12% silt
clayey.....>12% clay

Fines (Silt or Clay)

with gravel....15-29% gravel
gravelly.....>=30% gravel
with sand.....15-29% sand
sandy.....>=30% sand

RELATIVE DENSITY

COHESIONLESS SOILS

Term	"N" Value
Very Loose.....	0-4
Loose.....	4-10
Medium Dense.....	10-30
Dense.....	30-50
Very Dense.....	over 50

The penetration resistance, N, is the summation of the number of blows required to affect two successive 6" penetrations of the 2" split-barrel sampler. The sampler is driven with a 140 lb. weight falling 30" and is seated to a depth of 6" before commencing the standard penetration test (ASTM 1586).

CONSISTENCY

COHESIVE SOILS

Term	pp (tons/sq. ft.)	"N" Value
Very Soft.....	0.00 to 0.25.....	<2
Soft.....	0.25 to 0.50.....	2-4
Medium.....	0.50 to 1.00.....	4-8
Stiff.....	1.00 to 2.00.....	8-15
Very Stiff.....	2.00 to 4.00.....	15-30
Hard.....	over 4.00.....	>30

PLASTICITY

Term	Plasticity Index
None to slight.....	0 to 4
Slight.....	5 to 7
Medium.....	8 to 22
High to Very High.....	over 22

DRILLING AND SAMPLING

CS--Continuous Sampling
RC--Rock Coring: Size AW, BW, NW, 2" W
RQD--Rock Quality Designator
RB--Rock Bit
FT--Fish Tail
DC--Drove Casing
C--Casing: Size 2 1/2", NW, 4", HW
CW--Clear Water
DM--Drilling Mud
HSA--Hollow Stem Auger
FA--Flight Auger
HA--Hand Auger
SS--2" Diameter Split-Barrel Sample
2ST--2" Diameter Thin-Walled Tube Sample
3ST--3" Diameter Thin-Walled Tube Sample
PT--3" Diameter Piston Tube Sample
AS--Auger Sample
PS--Pitcher Sample
NR--No Recovery
VS--Vane Shear Test

LABORATORY TESTS

pp--Penetrometer Reading, tons/sq.ft.
qu--Unconfined Strength, tons/sq. ft.
MC--Moisture Content, %
LL--Liquid Limit, %
PL--Plastic Limit, %
PI--Plasticity Index, %
SL--Shrinkage Limit, %
LI--Loss on Ignition, %
D--Dry Unit Weight, lbs./cu. ft.
pH--Measure of Soil Alkalinity or Acidity
FS--Free Swell, %
HNu--ppmv as Benzene
TLV--ppmv as Hexane
TPH--Total Petroleum Hydrocarbons, ppm

WATER LEVEL

MEASUREMENTS

--Water Table Interpretation

Note: Water level measurements recorded in notes on the boring logs represent conditions at the time indicated and may not reflect static levels, especially in cohesive soils.

Project: POND STABILITY EVALUATION	Job No: 10-1-18634	Boring No: C
Client: ALLIANT UTILITIES	Drilled By: M&K ENV & SOILS DRILLING	Elevation: 590.1
Location: EDGEWATER - SHEBOYGAN, WI	Drilling Begun: 12/20/10	Drilling Completed: 12/20/10

SAMPLE TYPE 1" Geoprobe No Recovery Grab Sample Auger Sample 3" Shelby Tube 2" Split Spoon

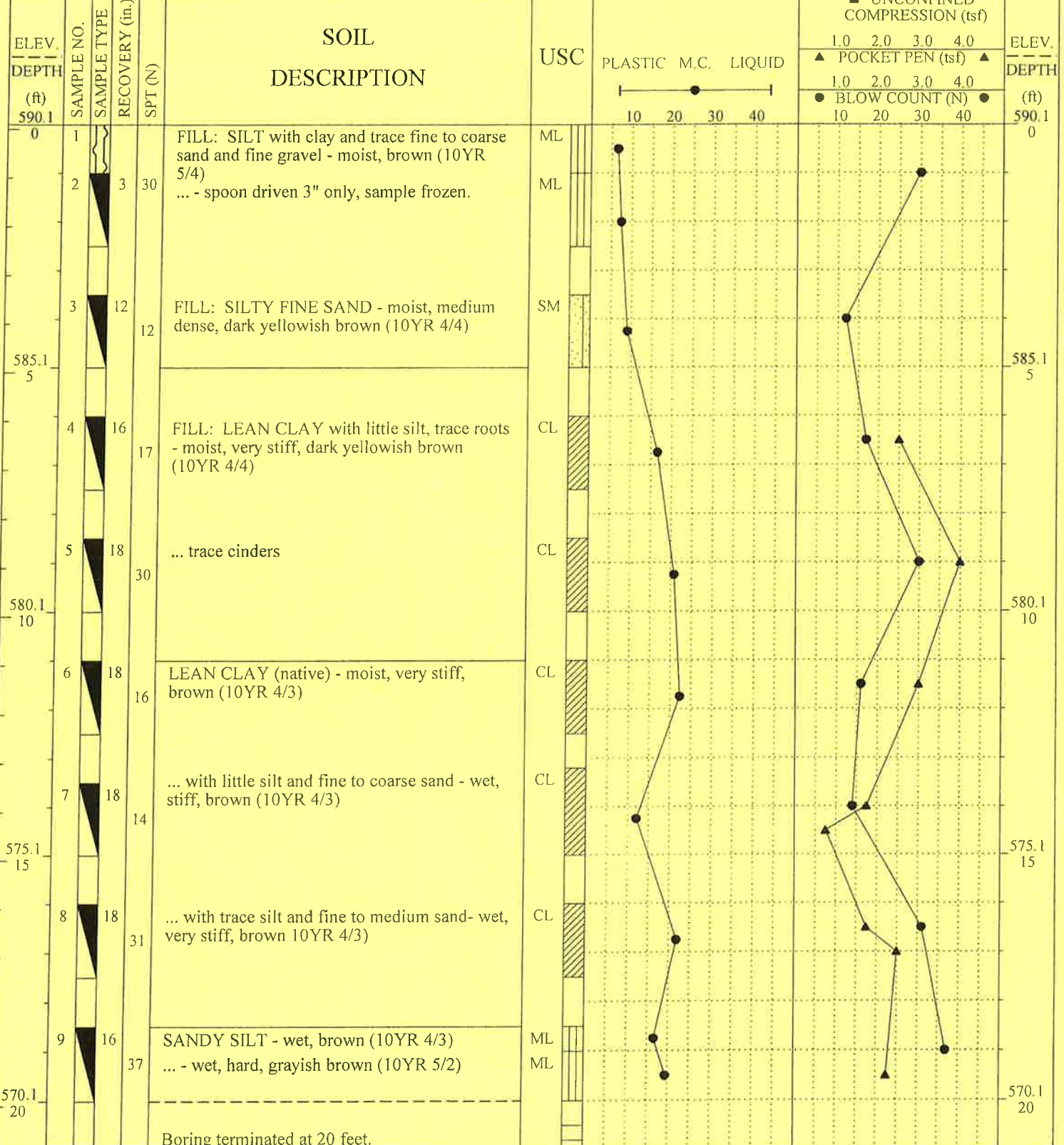

Boring terminated at 20 feet.

GEOLOG GINT_18634.GPJ MILLR_ENG.GDT 2/9/11 09:59

MILLER ENGINEERS SCIENTISTS

Date: 12/20/2010	Time: _____	dry ft. 13	ft. _____
Date: _____	Time: _____	ft. _____	ft. _____
Date: _____	Time: _____	ft. _____	ft. _____

Water Level	Cave-in Depth	Borehole Abandonment
		Date: 12/20/2010
		Material: BENTONITE

Crew: M&K Drill/WGF
Rig: Mobile B52
Method: HSA

Project: POND STABILITY EVALUATION	Job No: 10-1-18634	Boring No: D
Client: ALLIANT UTILITIES	Drilled By: M&K ENV & SOILS DRILLING	Elevation: 590.9
Location: EDGEWATER - SHEBOYGAN, WI	Drilling Begun: 12/10/10	Drilling Completed: 12/10/10

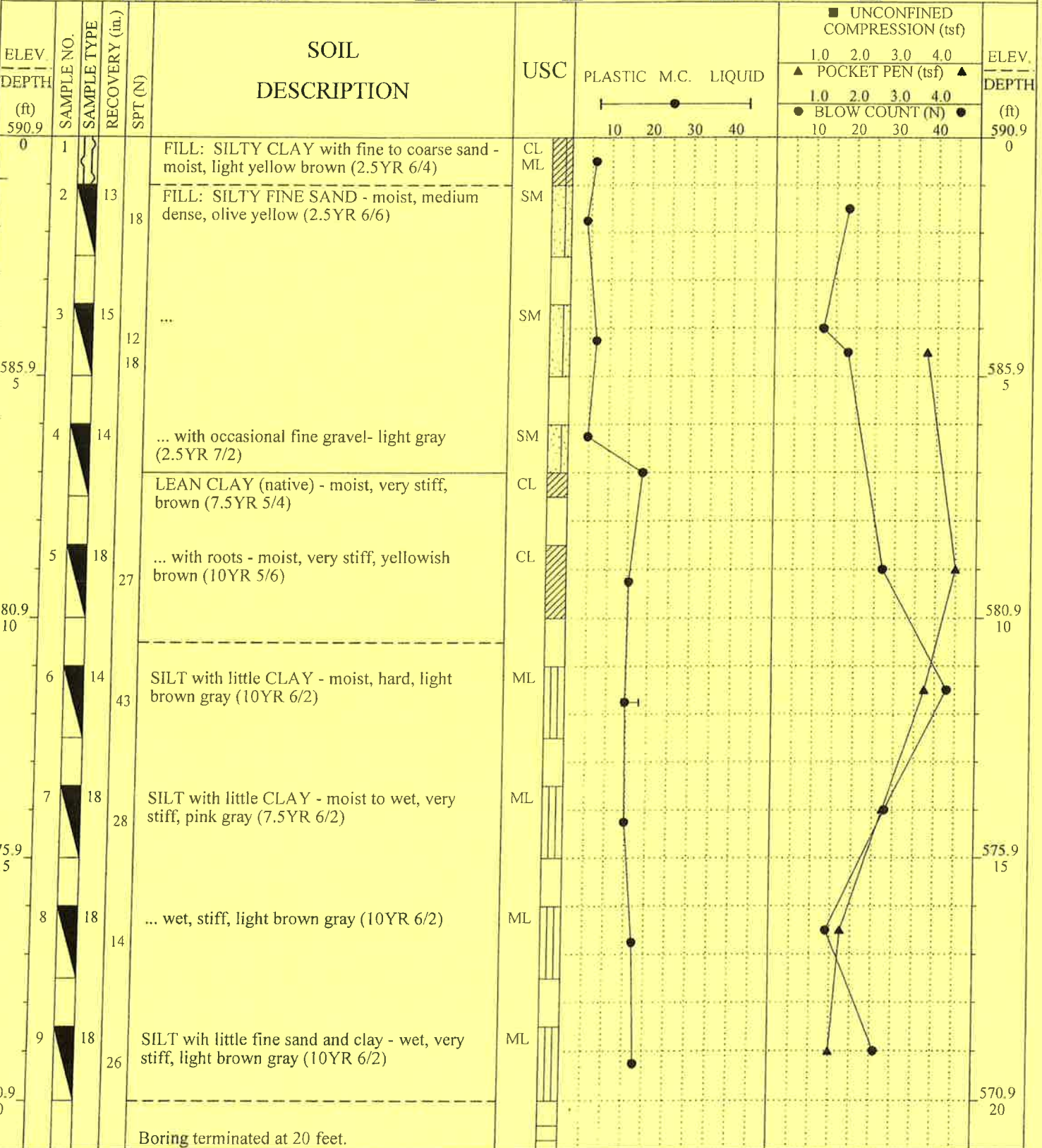

GEOLOG GINT_18634.GPJ MLLR_ENG GDT 2/19/11 09:59



Date _____ Time _____ ft. _____ ft.		Water Level		Cave-in Depth		Borehole Abandonment		Crew: M&K Drill/WGF	
Date _____ Time _____ ft. _____ ft.						Date: 12/10/2010		Rig: Mobile B52	
Date _____ Time _____ ft. _____ ft.						Material: BENTONITE		Method: HSA	

Project: POND STABILITY EVALUATION	Job No: 10-1-18634	Boring No: E
Client: ALLIANT UTILITIES	Drilled By: M&K ENV & SOILS DRILLING	Elevation: 607.9
Location: EDGEWATER - SHEBOYGAN, WI	Drilling Begun: 12/21/10	Drilling Completed: 12/21/10

SAMPLE TYPE 1" Geoprobe No Recovery Grab Sample Auger Sample 3" Shelby Tube 2" Split Spoon

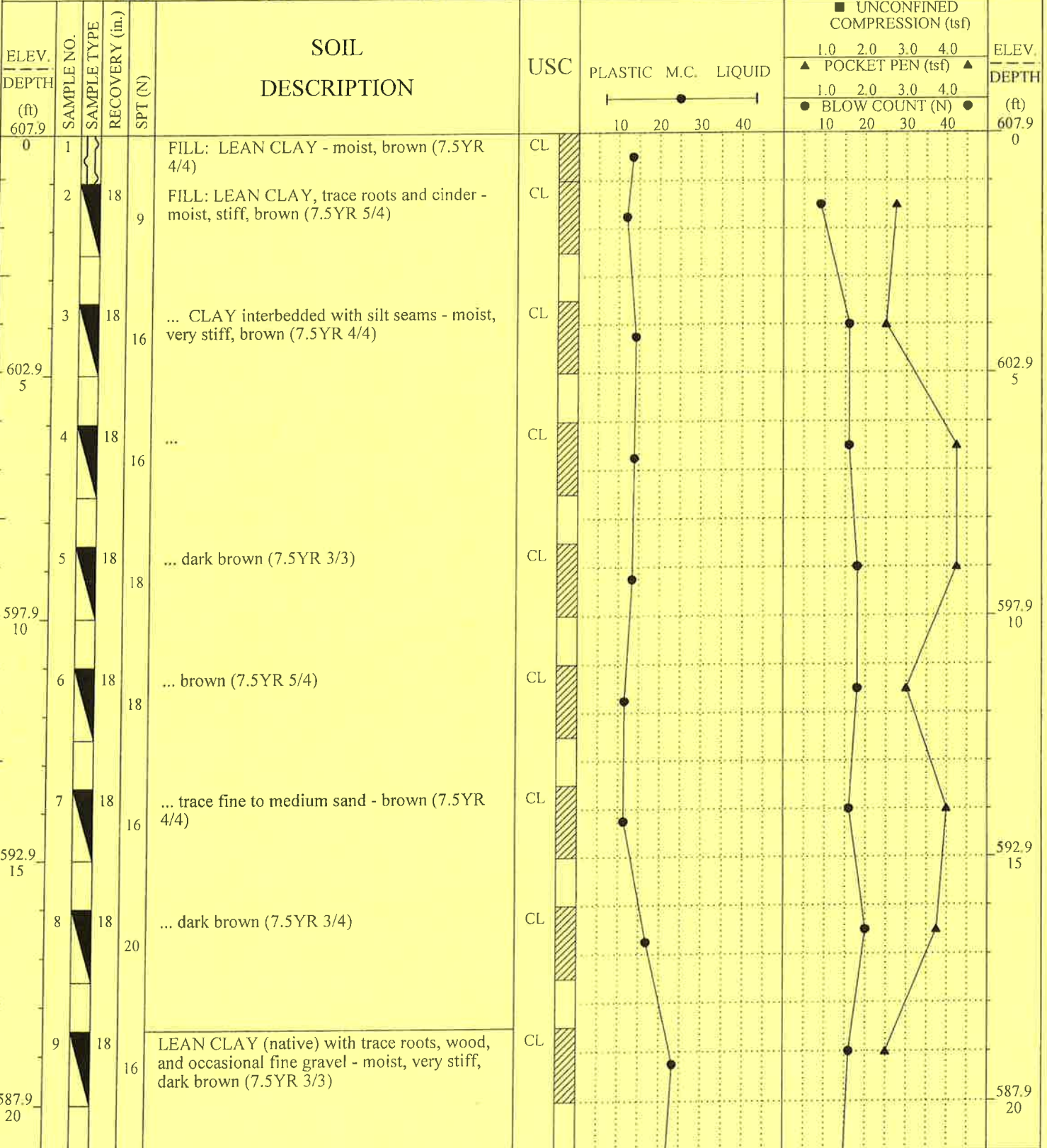

GEOTLOG GINT_18634.GPJ MILLR_ENG.GDT 2/9/11 09:59

MILLER ENGINEERS SCIENTISTS

Date: 12/21/2010	Time: 3 ft.	32.5 ft.
Date: _____	Time: _____	_____
Date: _____	Time: _____	_____

Water Level	Cave-in Depth	Borehole Abandonment
		Date: 12/21/2010
		Material: BENTONITE

Crew: M&K Drill/WGF
Rig: Mobile B52
Method: HSA

Project: POND STABILITY EVALUATION	Job No: 10-1-18634	Boring No: E
Client: ALLIANT UTILITIES	Drilled By: M&K ENV & SOILS DRILLING	Elevation: 607.9
Location: EDGEWATER - SHEBOYGAN, WI	Drilling Begun: 12/21/10	Drilling Completed: 12/21/10
SAMPLE TYPE <input checked="" type="checkbox"/> 1" Geoprobe <input type="checkbox"/> No Recovery <input type="checkbox"/> Grab Sample <input type="checkbox"/> Auger Sample <input checked="" type="checkbox"/> 3" Shelby Tube <input checked="" type="checkbox"/> 2" Split Spoon		

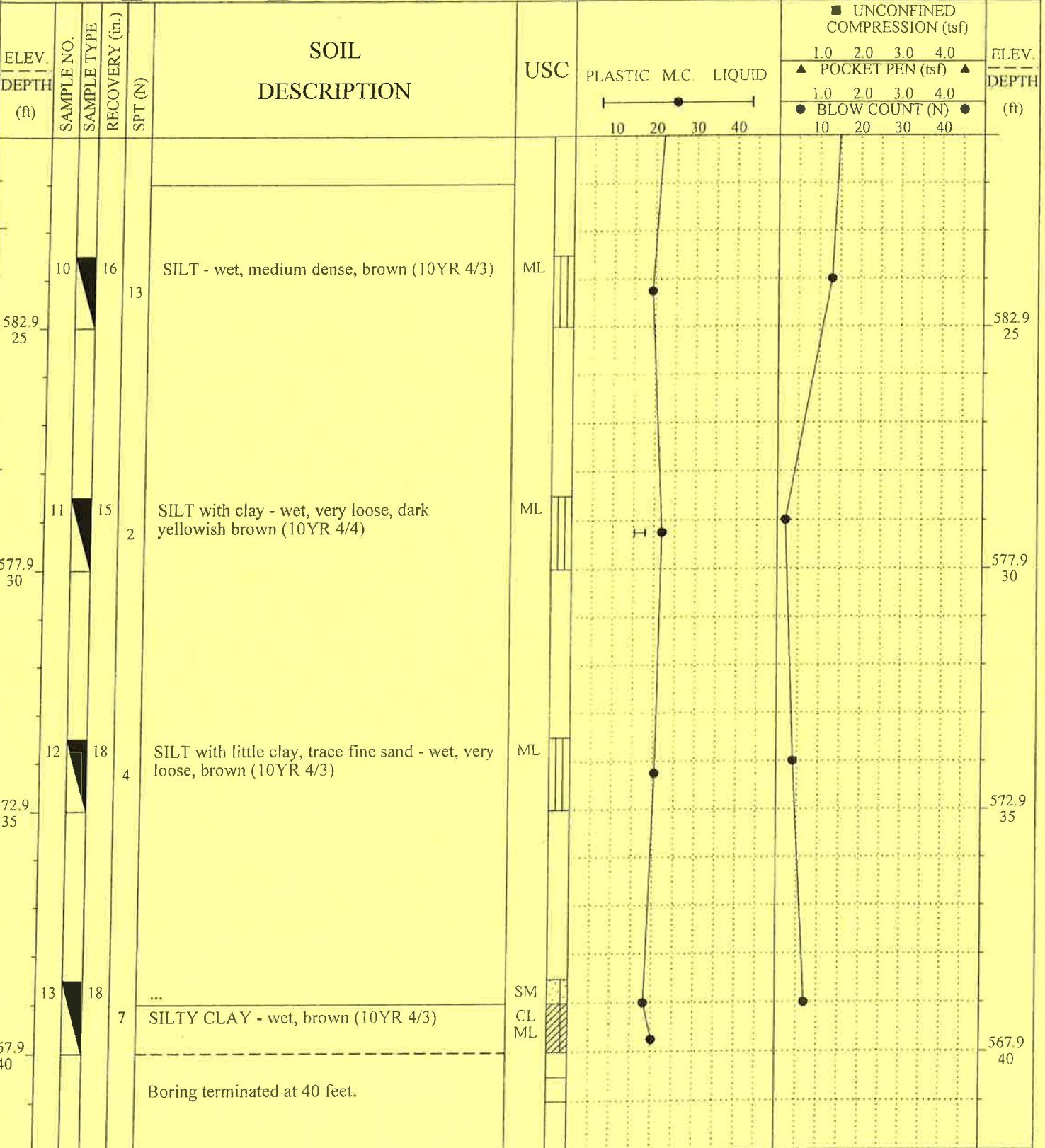

GEOLOG GINT_18634.GPJ_MLLR_ENG.GDT_2/9/11 09:59



Date: 12/21/2010	Time: _____	Water Level: 3 ft.	Cave-in Depth: 32.5 ft.	Borehole Abandonment Date: 12/21/2010	Crew: M&K Drill/WGF
Date: _____	Time: _____			Material: BENTONITE	Rig: Mobile B52
Date: _____	Time: _____				Method: HSA

Project: POND STABILITY EVALUATION	Job No: 10-1-18634	Boring No: F
Client: ALLIANT UTILITIES	Drilled By: M&K ENV & SOILS DRILLING	Elevation: 609.0
Location: EDGEWATER - SHEBOYGAN, WI	Drilling Begun: 12/21/10	Drilling Completed: 12/21/10
SAMPLE TYPE <input checked="" type="checkbox"/> 1" Geoprobe <input type="checkbox"/> No Recovery <input checked="" type="checkbox"/> Grab Sample <input type="checkbox"/> Auger Sample <input type="checkbox"/> 3" Shelby Tube <input type="checkbox"/> 2" Split Spoon		

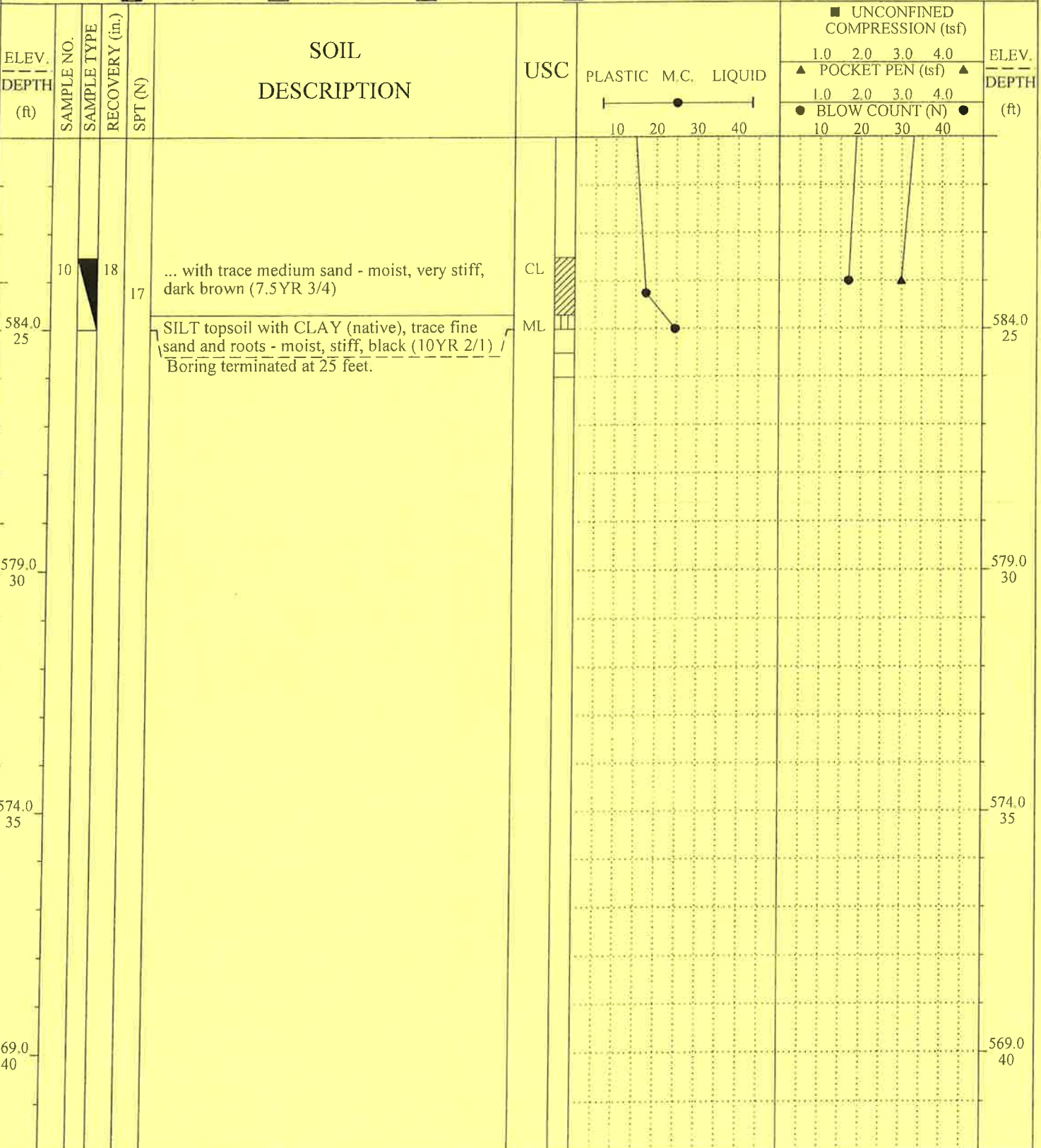

GEOTLOG GINT_18634.GPJ MILLR_ENG.GDT 2/9/11 09:59

MILLER ENGINEERS SCIENTISTS	Water Level Cave-in Depth		Borehole Abandonment		Crew: M&K Drill/WGF
	Date 12/21/2010	Time dry ft. 26 ft.	Date: 12/21/2010	Material: BENTONITE	Rig: Mobile B52
	Date _____	Time _____	Date _____	Method: HSA	

Project: POND STABILITY EVALUATION	Job No: 10-1-18634	Boring No: F
Client: ALLIANT UTILITIES	Drilled By: M&K ENV & SOILS DRILLING	Elevation: 609.0
Location: EDGEWATER - SHEBOYGAN, WI	Drilling Begun: 12/21/10	Drilling Completed: 12/21/10
SAMPLE TYPE <input checked="" type="checkbox"/> 1" Geoprobe <input type="checkbox"/> No Recovery <input checked="" type="checkbox"/> Grab Sample <input type="checkbox"/> Auger Sample <input type="checkbox"/> 3" Shelby Tube <input type="checkbox"/> 2" Split Spoon		

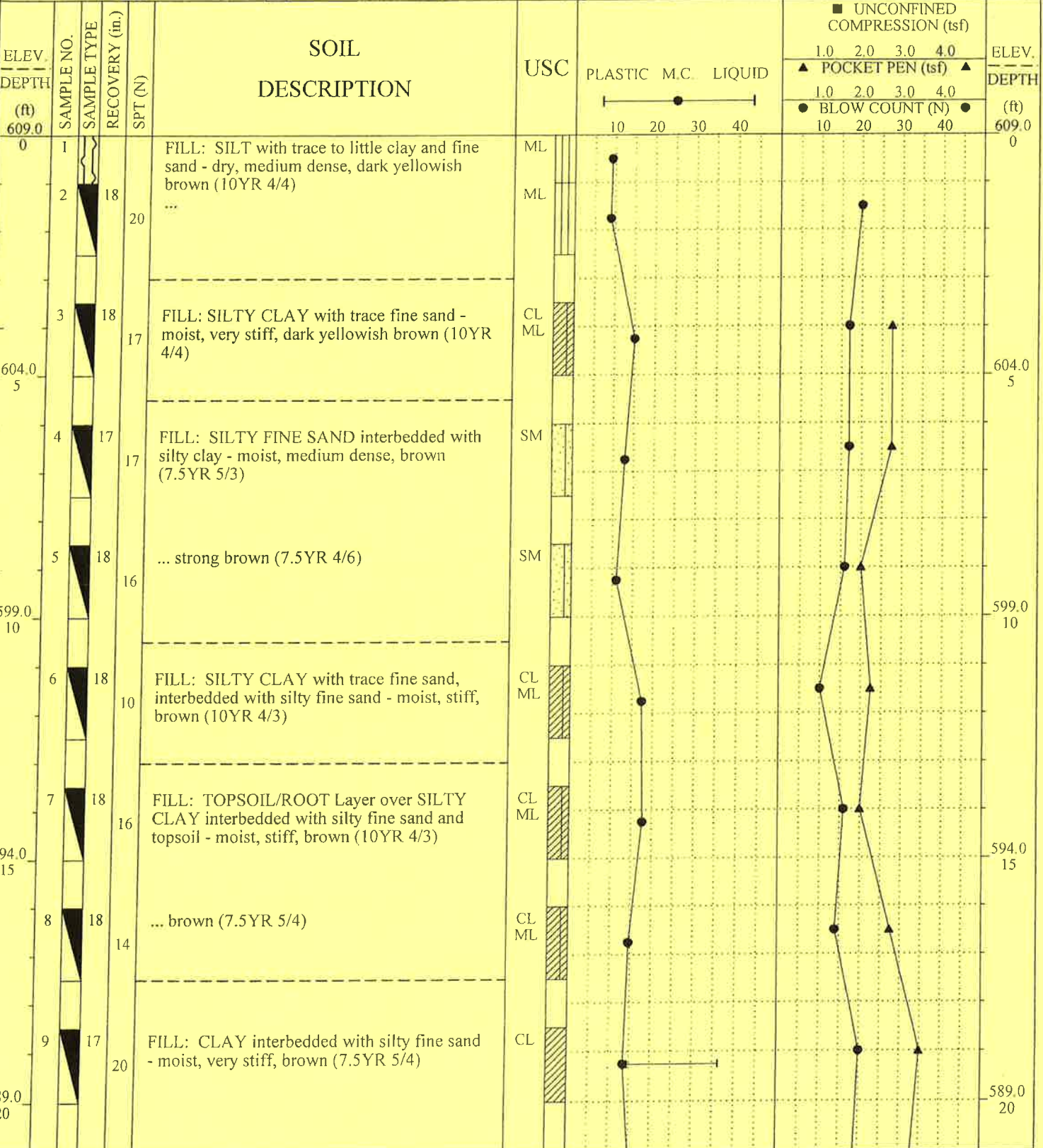

GEOLOG GINT 18634.GPJ MILLR_ENG.GDT 2/9/11 09:59

MILLER ENGINEERS SCIENTISTS

Date: 12/21/2010	Time: _____	Water Level: _____	Cave-in Depth: _____	Borehole Abandonment Date: 12/21/2010	Material: BENTONITE
Date: _____	Time: _____	ft. _____	ft. _____		
Date: _____	Time: _____	ft. _____	ft. _____		

Crew: M&K Drill/WGF
Rig: Mobile B52
Method: HSA

Project: POND STABILITY EVALUATION	Job No: 10-1-18634	Boring No: I
Client: ALLIANT UTILITIES	Drilled By: M&K ENV & SOILS DRILLING	Elevation: 611.9
Location: EDGEWATER - SHEBOYGAN, WI	Drilling Begun: 12/21/10	Drilling Completed: 12/21/10

SAMPLE TYPE 1" Geoprobe No Recovery Grab Sample Auger Sample 3" Shelby Tube 2" Split Spoon

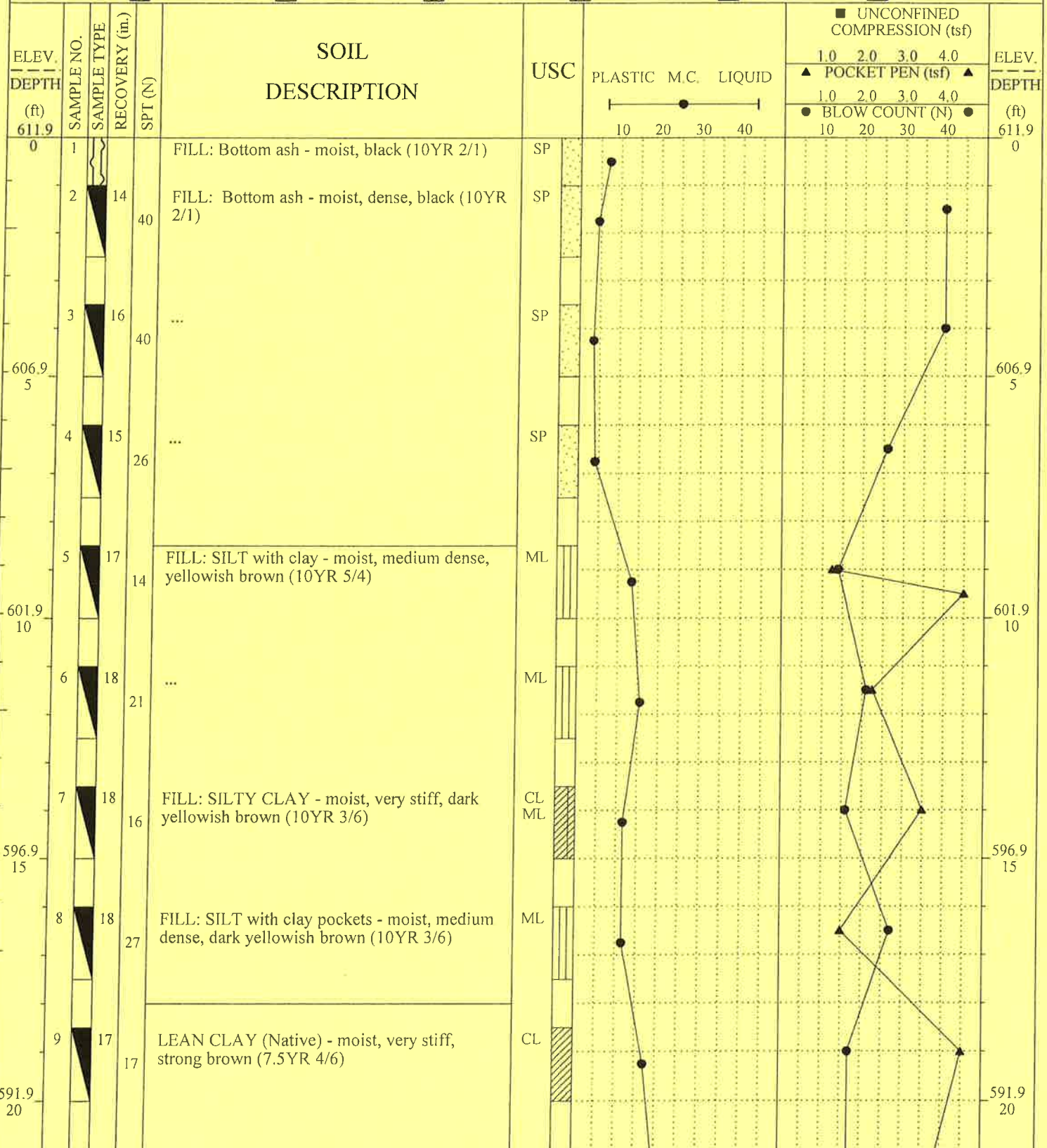

GEOTLOG GINT_18634.GPJ MILLR ENG GDT 29/11 09:59

MILLER ENGINEERS SCIENTISTS

Date	12/21/2010	Time	dry	ft.	27	ft.
Date		Time		ft.		ft.
Date		Time		ft.		ft.

Water Level	Cave-in Depth	Borehole Abandonment
		Date: 12/21/2010
		Material: BENTONITE

Crew:	M&K Drill/WGF
Rig:	Mobile B52
Method:	HSA

Project: POND STABILITY EVALUATION	Job No: 10-1-18634	Boring No: I
Client: ALLIANT UTILITIES	Drilled By: M&K ENV & SOILS DRILLING	Elevation: 611.9
Location: EDGEWATER - SHEBOYGAN, WI	Drilling Begun: 12/21/10	Drilling Completed: 12/21/10

SAMPLE TYPE 1" Geoprobe No Recovery Grab Sample Auger Sample 3" Shelby Tube 2" Split Spoon

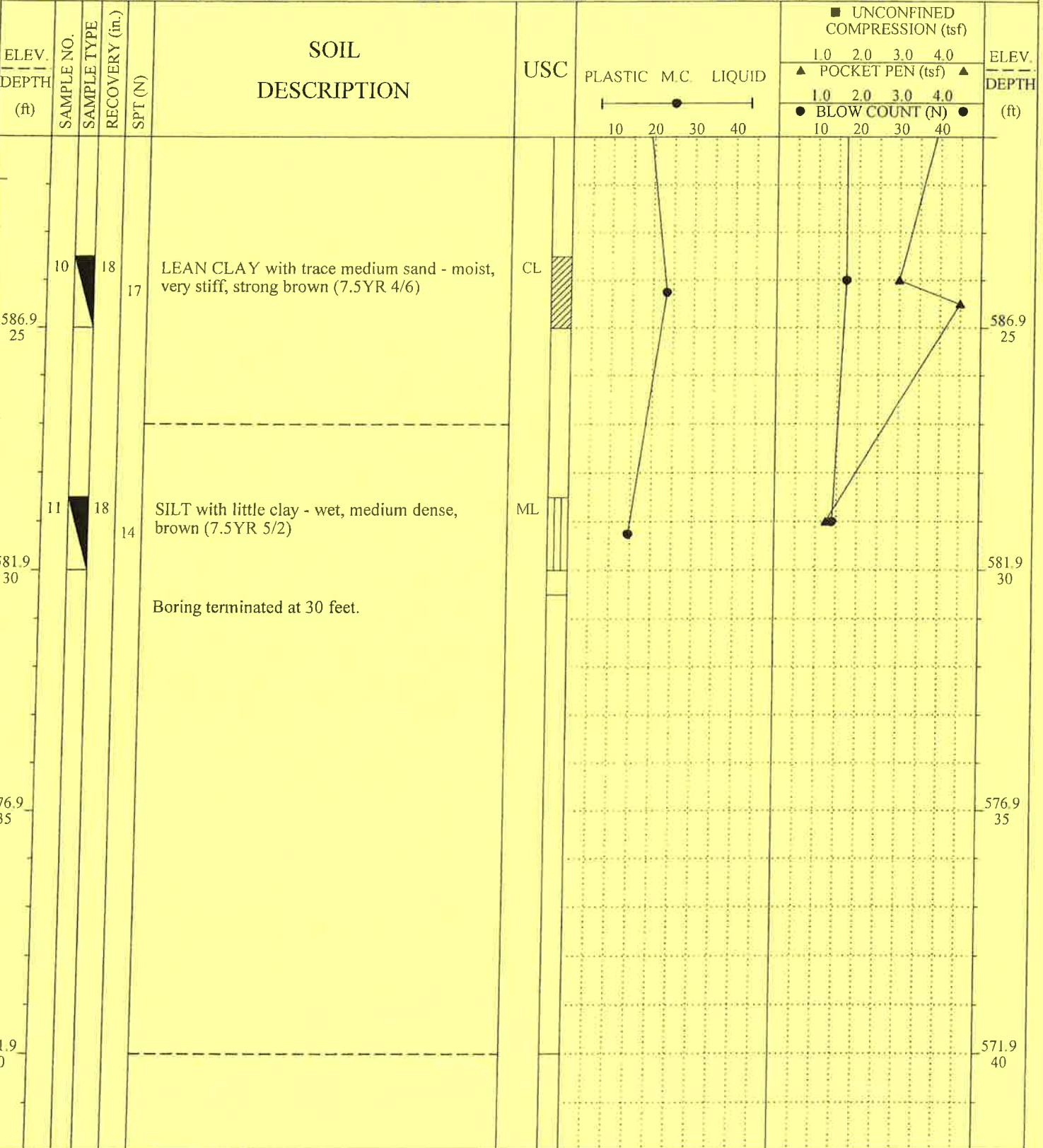

GEOLOG GINT_18634.GPJ MILLR_ENG.GDT 2/9/11 09:59

MILLER ENGINEERS SCIENTISTS

Water Level Cave-in Depth Borehole Abandonment

Date 12/21/2010 Time _____ dry ft. 27 ft.

Date _____ Time _____ ft. _____ ft.

Date _____ Time _____ ft. _____ ft.

Crew: **M&K Drill/WGF**

Rig: **Mobile B52**

Method: **HSA**

Date: **12/21/2010**

Material: **BENTONITE**

Project: POND STABILITY EVALUATION	Job No: 10-1-18634	Boring No: N
Client: ALLIANT UTILITIES	Drilled By: M&K ENV & SOILS DRILLING	Elevation: 611.8
Location: EDGEWATER - SHEBOYGAN, WI	Drilling Begun: 12/21/10	Drilling Completed: 12/21/10
SAMPLE TYPE <input checked="" type="checkbox"/> 1" Geoprobe <input type="checkbox"/> No Recovery <input type="checkbox"/> Grab Sample <input type="checkbox"/> Auger Sample <input checked="" type="checkbox"/> 3" Shelby Tube <input type="checkbox"/> 2" Split Spoon		

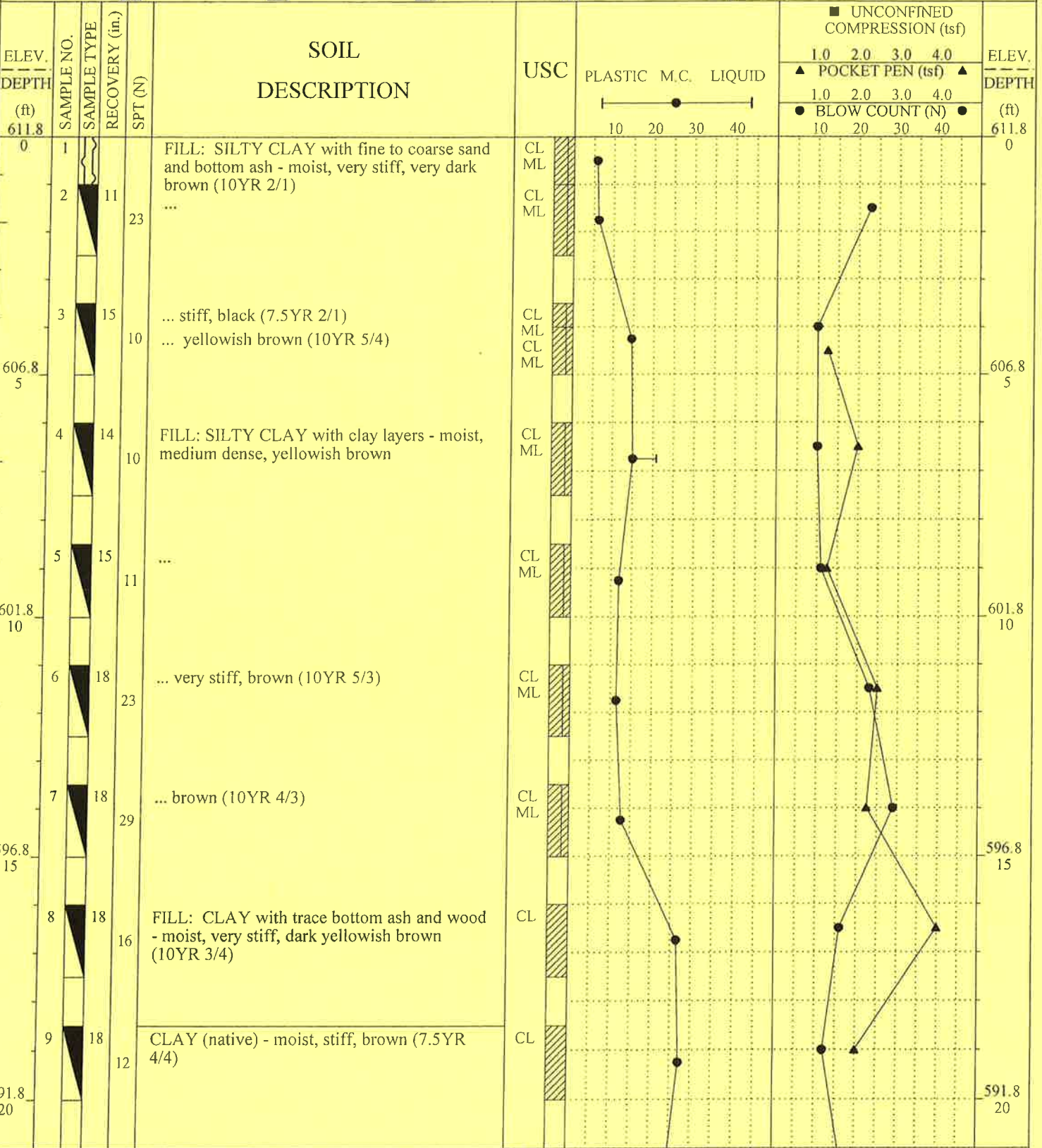

GEOLOG GINT_18634.GPJ MILLR_ENG.GDT 2/19/11 10:00



Date 12/21/2010 Time _____ dry ft. 29 ft.		Borehole Abandonment		Crew: M&K Drill/WGF
Date _____ Time _____ ft. _____ ft.	Date: 12/21/2010	Material: BENTONITE		Rig: Mobile B52
Date _____ Time _____ ft. _____ ft.			Method: HSA	

Project: POND STABILITY EVALUATION	Job No: 10-1-18634	Boring No: N
Client: ALLIANT UTILITIES	Drilled By: M&K ENV & SOILS DRILLING	Elevation: 611.8
Location: EDGEWATER - SHEBOYGAN, WI	Drilling Begun: 12/21/10	Drilling Completed: 12/21/10
SAMPLE TYPE <input checked="" type="checkbox"/> 1" Geoprobe <input type="checkbox"/> No Recovery <input checked="" type="checkbox"/> Grab Sample <input type="checkbox"/> Auger Sample <input type="checkbox"/> 3" Shelby Tube <input checked="" type="checkbox"/> 2" Split Spoon		

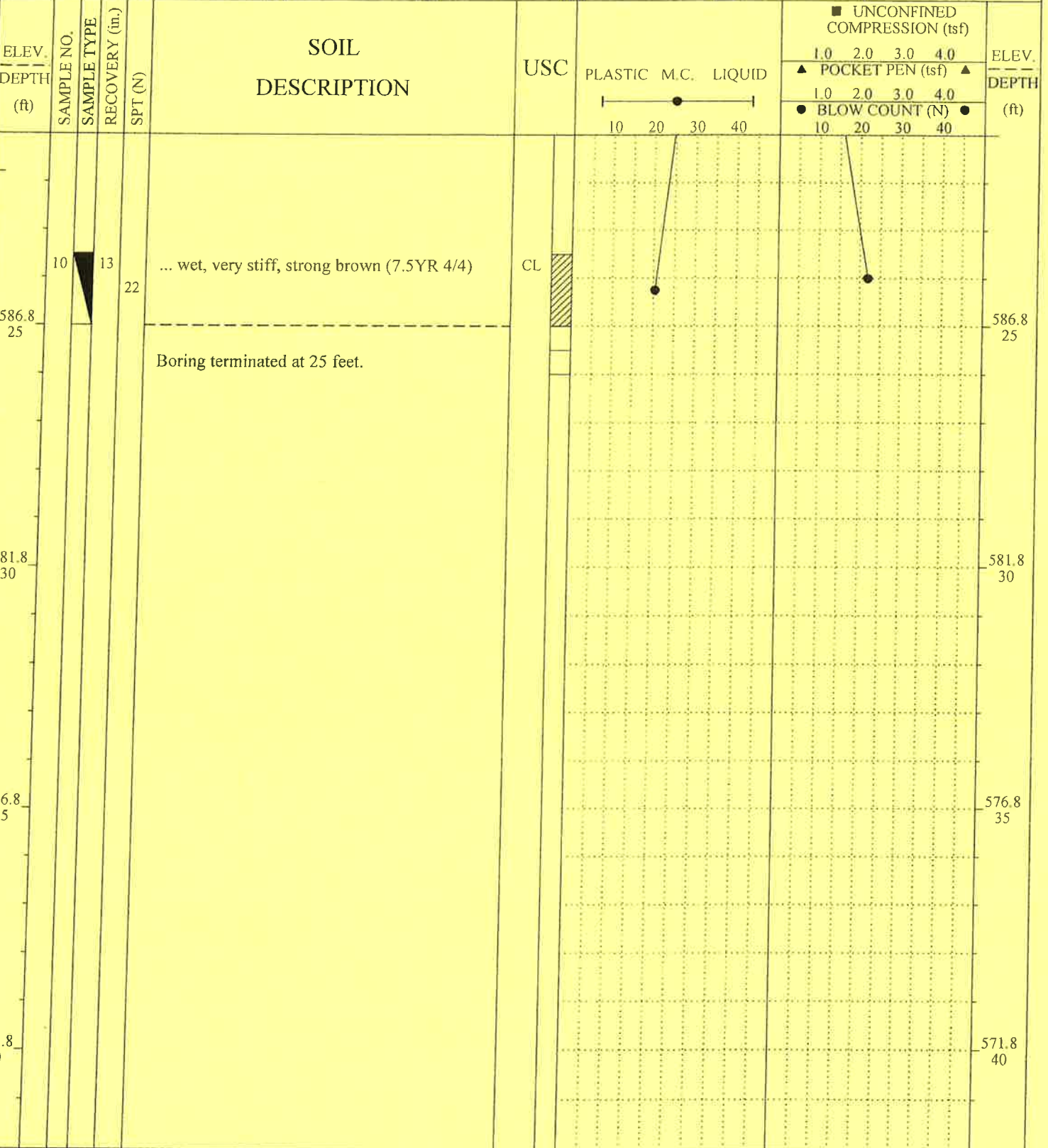

GEOLOG GINT_18634.GPJ MILLR_ENG.GDT 2/9/11 10:00

MILLER ENGINEERS SCIENTISTS

Date 12/21/2010 Time dry ft. 29 ft.		Water Level		Cave-in Depth		Borehole Abandonment		Crew: M&K Drill/WGF	
Date	Time	ft.	ft.	Date:	12/21/2010	Rig:	Mobile B52	Method: HSA	
Date	Time	ft.	ft.	Material:	BENTONITE				

Project: POND STABILITY EVALUATION	Job No: 10-1-18634	Boring No: P
Client: ALLIANT UTILITIES	Drilled By: M&K ENV & SOILS DRILLING	Elevation: 609.7
Location: EDGEWATER - SHEBOYGAN, WI	Drilling Begun: 12/20/10	Drilling Completed: 12/20/10
SAMPLE TYPE <input checked="" type="checkbox"/> 1" Geoprobe <input type="checkbox"/> No Recovery <input type="checkbox"/> Grab Sample <input checked="" type="checkbox"/> Auger Sample <input type="checkbox"/> 3" Shelby Tube <input type="checkbox"/> 2" Split Spoon		

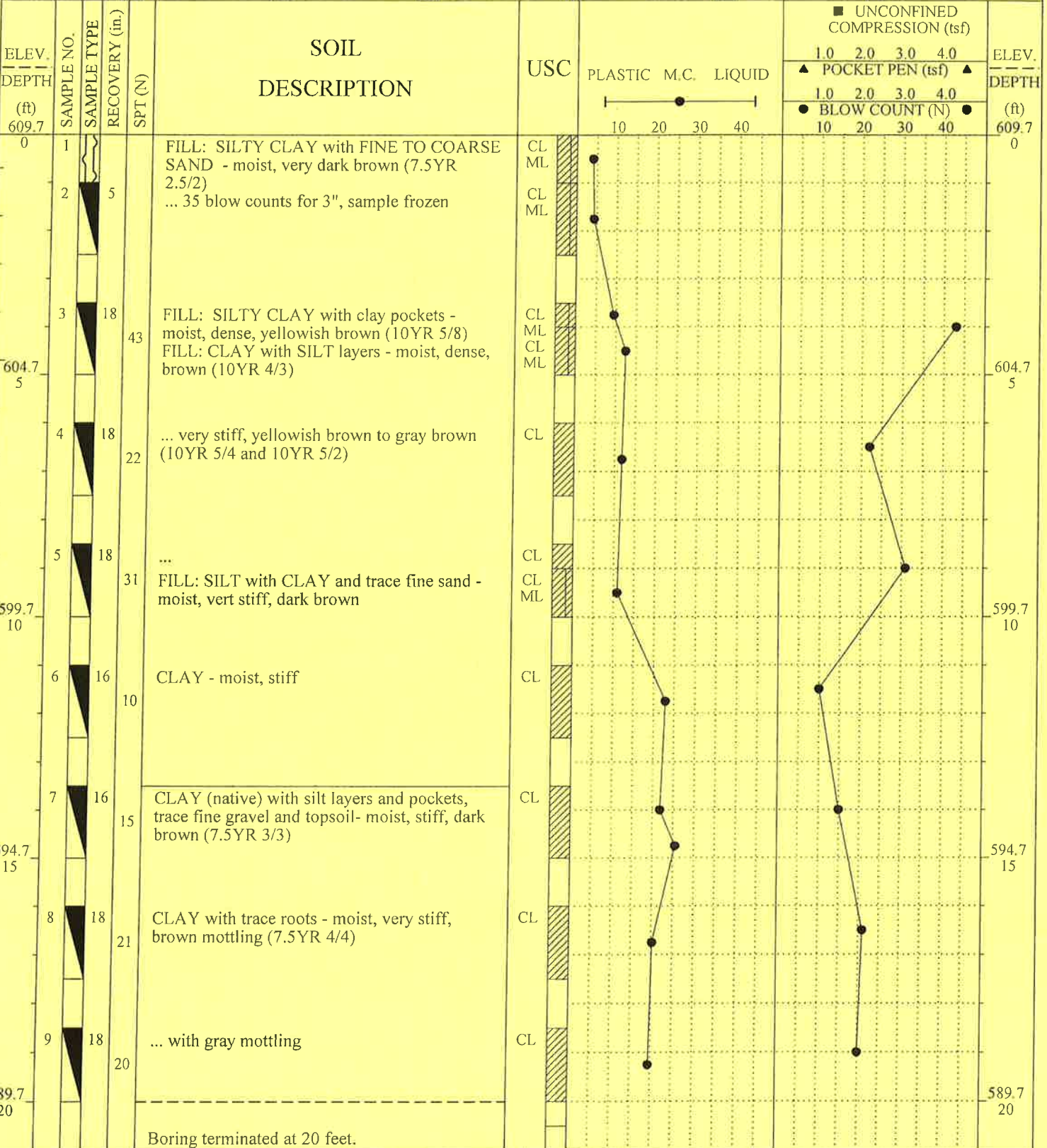

GEOLOG GINT_18634.GPJ MILLR_ENG.GDT 2/9/11 10:00

MILLER ENGINEERS SCIENTISTS

Date: 12/20/2010	Time: _____	Water Level: _____	Cave-in Depth: 16 ft.	Borehole Abandonment	Crew: M&K Drill/WGF
Date: _____	Time: _____	ft. _____	ft. _____	Date: 12/20/2010	Rig: Mobile B52
Date: _____	Time: _____	ft. _____	ft. _____	Material: BENTONITE	Method: HSA

Project: POND STABILITY EVALUATION	Job No: 10-1-18634	Boring No: Q
Client: ALLIANT UTILITIES	Drilled By: M&K ENV & SOILS DRILLING	Elevation: 609.2
Location: EDGEWATER - SHEBOYGAN, WI	Drilling Begun: 2/23/11	Drilling Completed: 2/23/11

SAMPLE TYPE 1" Geoprobe No Recovery Grab Sample Auger Sample 3" Shelby Tube 2" Split Spoon

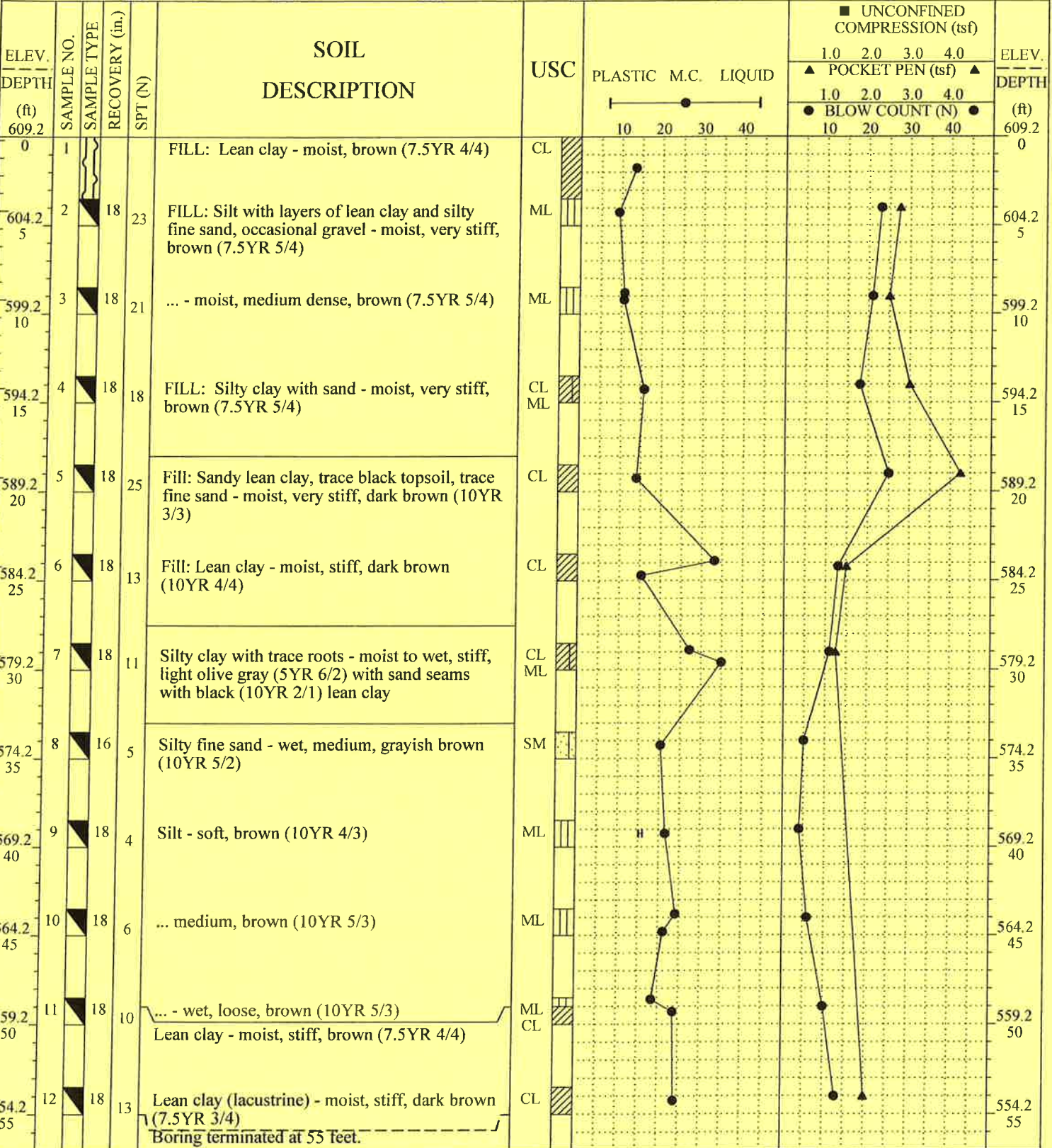

GEOLOG GINT 18634.GPJ MLLR.ENG.GDT 3/16/11 10:17

MILLER ENGINEERS SCIENTISTS

Water Level		Cave-in Depth		Borehole Abandonment		Crew: M&K Drill/WGF	
Date _____	Time _____	ft. _____	ft. _____	Date: 2/23/2011		Rig: Mobile B52	
Date _____	Time _____	ft. _____	ft. _____	Material: BENTONITE		Method: Mud Rotary	

Project: POND STABILITY EVALUATION	Job No: 10-1-18634	Boring No: R
Client: ALLIANT UTILITIES	Drilled By: M&K ENV & SOILS DRILLING	Elevation: 612.2
Location: EDGEWATER - SHEBOYGAN, WI	Drilling Begun: 2/24/11	Drilling Completed: 2/24/11
SAMPLE TYPE <input checked="" type="checkbox"/> 1" Geoprobe <input type="checkbox"/> No Recovery <input checked="" type="checkbox"/> Grab Sample <input type="checkbox"/> Auger Sample <input type="checkbox"/> 3" Shelby Tube <input checked="" type="checkbox"/> 2" Split Spoon		

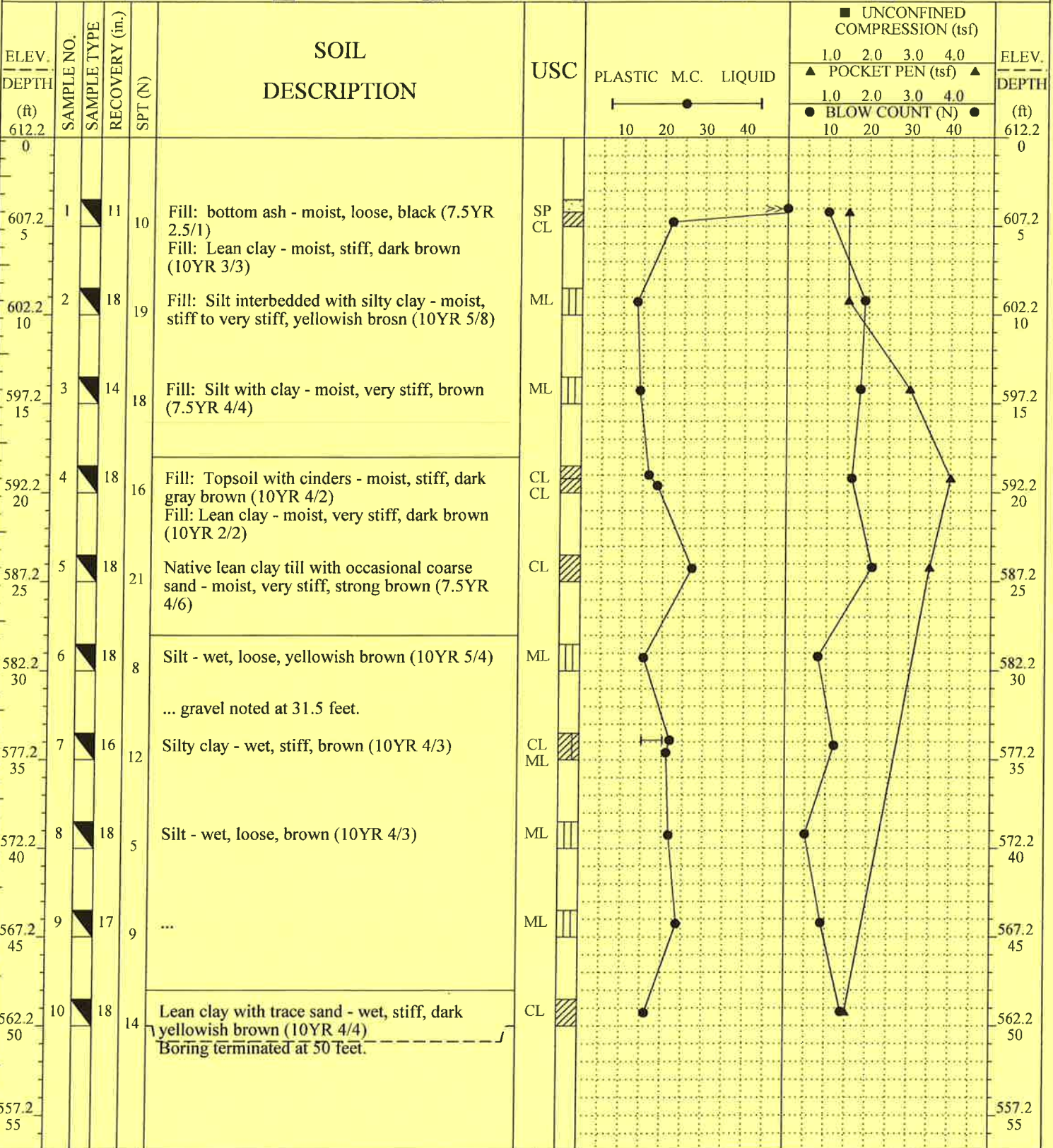

GEOTLOG GINT 18634.GPJ MILLR_ENG_GDT 3/16/11 10:17

MILLER ENGINEERS SCIENTISTS

Date _____ Time _____ ft. _____ ft.		Water Level _____ Cave-in Depth _____		Borehole Abandonment		Crew: M&K Drill/WGF	
Date _____ Time _____ ft. _____ ft.		Date: 2/24/2011		Material: BENTONITE		Rig: Mobile B52	
Date _____ Time _____ ft. _____ ft.						Method: Mud Rotary	

**APPENDIX E – EDG Existing CCR
Surface Impoundment Drawings**

Alliant Energy
Wisconsin Power and Light Company
Edgewater Generating Station
Sheboygan, Wisconsin

History of Construction



WISCONSIN POWER & LIGHT COMPANY

EDGEWATER CLOSED ASH DISPOSAL FACILITY

NR 140 COMPLIANCE REPORT
WDNR LICENSE #2524

PREPARED BY: DAMES & MOORE
MADISON, WISCONSIN

SUBMITTAL DATE: FEBRUARY 1991

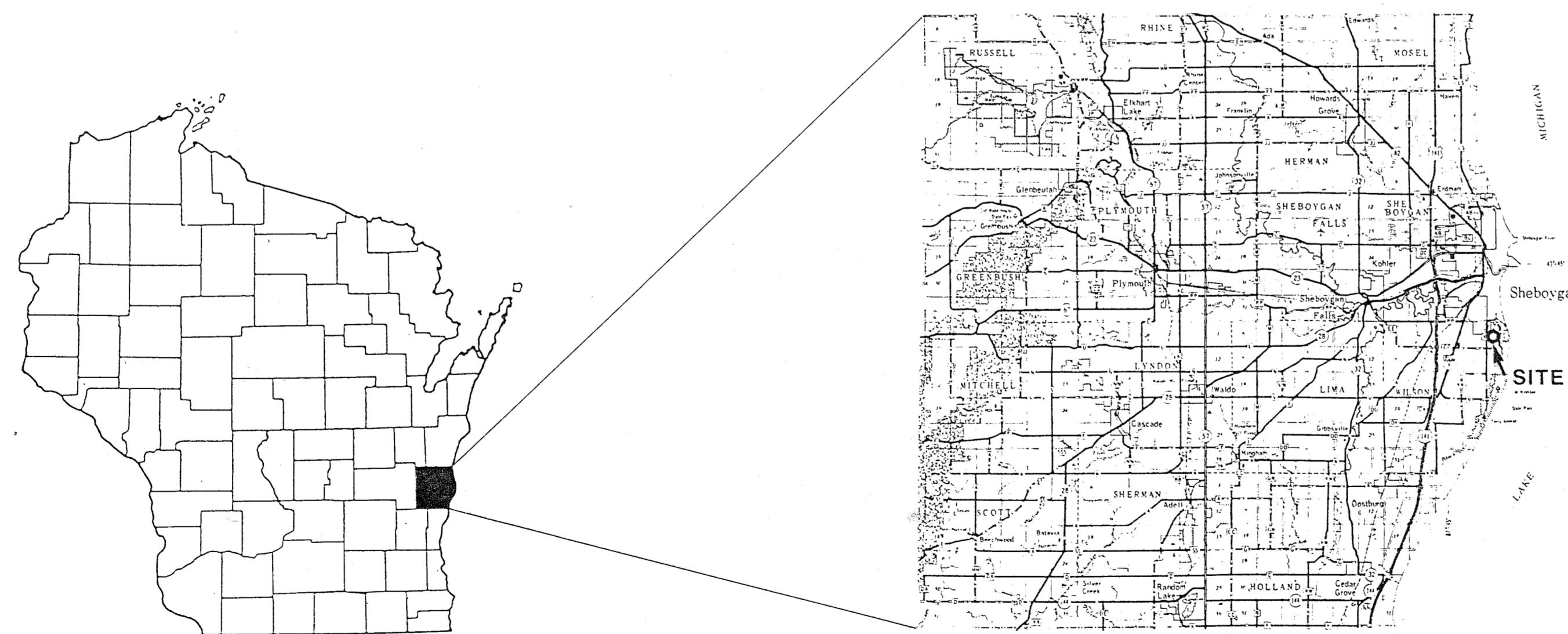

STATE LOCATOR MAP

COUNTY LOCATOR MAP

INDEX

SHEET TITLE

1	CROSS SECTION LOCATOR MAP
2	GEOLOGIC CROSS SECTIONS A-A' AND B-B'
3	WATER TABLE CONTOUR MAP
4	TDS ISOCONCENTRATION MAP: GLACIAL AQUIFER
5	TDS ISOCONCENTRATION MAP: DOLOMITE AQUIFER
6	BORON ISOCONCENTRATION MAP: GLACIAL AQUIFER
7	BORON ISOCONCENTRATION MAP: DOLOMITE AQUIFER
8	SULFATE ISOCONCENTRATION MAP: GLACIAL AQUIFER
9	SULFATE ISOCONCENTRATION MAP: DOLOMITE AQUIFER
10	IRON ISOCONCENTRATION MAP: GLACIAL AQUIFER
11	IRON ISOCONCENTRATION MAP: DOLOMITE AQUIFER

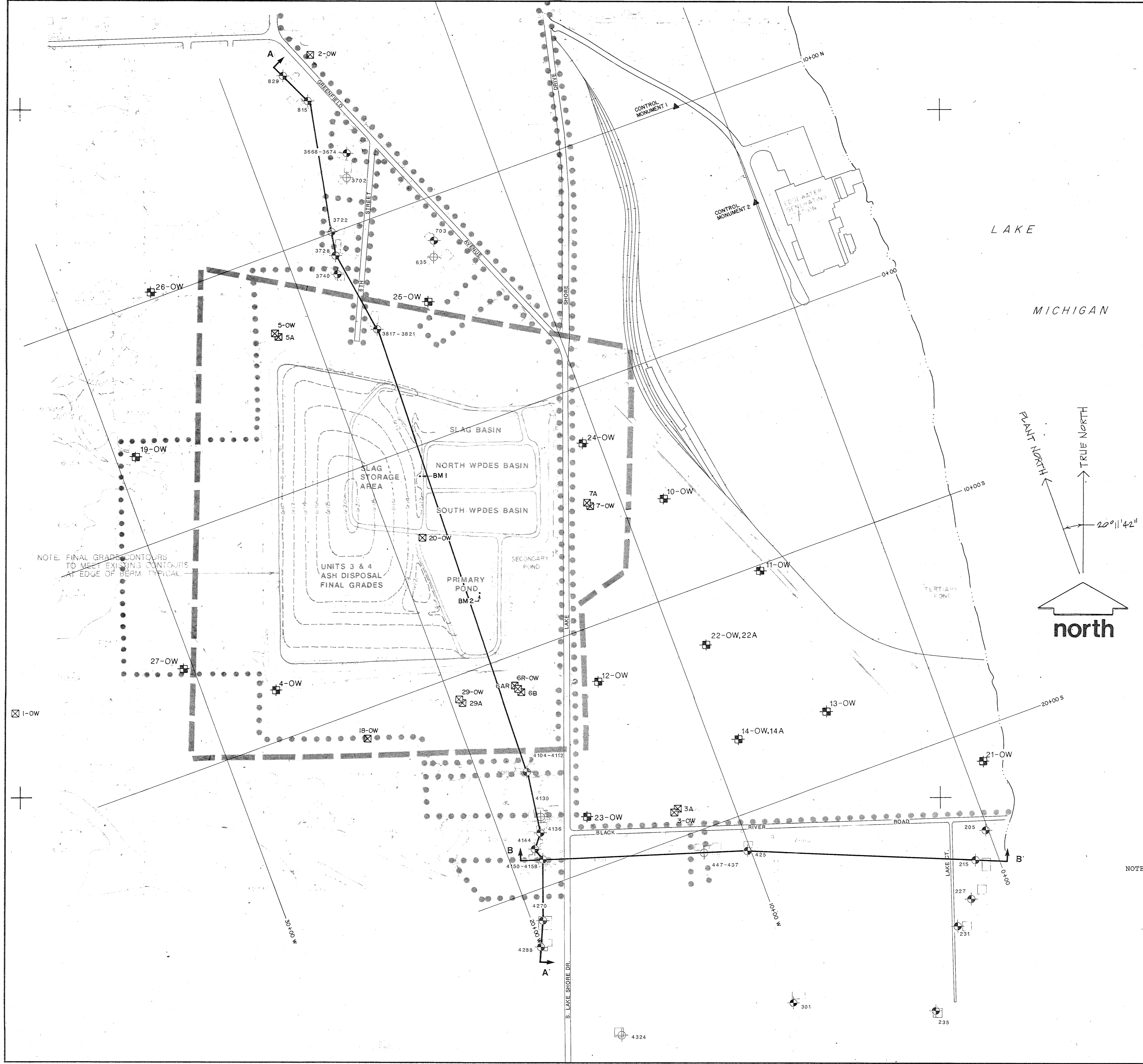

NOTE: FINAL GRADE CONTOURS TO MEET EXISTING CONTOURS AT EDGE OF BERM TYPICAL

OBSERVATION WELL DATA TABLE

Well Name	Well ID	Well Location	N	S	W	E	Established	Diam	Type	Top of Well Casing	Ground Surface Elevation	Screen Top	Reference	Length	Material	Well Depth	Other	Type of Well (1-1)
1-OW	201	489.0	X				2-19-76	2"	P	592.53'	590.36	586.55'	✓	5'	Slotted PVC	10.98'		
2-OW	202	1766.4	X				2-23-76	2"	P	612.28'	609.75	605.56'	✓	5'	Slotted PVC	11.72'		
3-OW	203	1883.3	X				2-17-76	2"	P	591.77'	589.71	585.94'	✓	5'	Slotted PVC	10.83'		
3A		1242.5	X				3-22-82	2"	P	592.22'	590.02	582.14'	✓	5'	Slotted PVC	15.08'		
5-OW	205	667.7	X				2-20-76	2"	P	601.77'	599.69	595.23'	✓	4'	Slotted PVC	10.54'		
5A	206	661.0	X				2-20-76	2"	P	601.37'	599.41	582.92'	✓	3'	Slotted PVC	21.45'		
6R-OW		1135.0	X				2-26-90	2"	P	591.85'	589.17	586.53'	✓	5'	Slotted PVC	10.32'		
6AR		1713.5	X				2-26-90	2"	P	591.34'	589.38	581.74'	✓	5'	Slotted PVC	14.60'		
6B	209	1137.4	X				2-19-76	2"	P	591.91'	589.64	578.15'	✓	3'	Slotted PVC	19.75'		
7-OW	210	499.8*	X				2-17-76	2"	P	593.76'	591.45	586.61'	✓	4'	Slotted PVC	11.15'		
7A	211	490.6	X				2-17-76	2"	P	593.90'	591.83	576.44'	✓	3'	Slotted PVC	20.46'		
18-OW	223	1151.8	X				6-6-78	2"	P	587.42'	584.99	581.04'	✓	10'	Slotted PVC	15.98'		
20-OW	220	1116.5	X				6-5-78	2"	P	615.88'	612.81	583.28'	✓	10'	Slotted PVC	42.60'		
29-OW	224	1093.6	X				11-27-84	2"	P	589.13	586.06	580.68'	✓	10'	Slotted PVC	18.45'		
29A	225	1960.6	X				11-27-84	2"	P	589.21	586.38	548.51'	✓	3'	Slotted PVC	43.70'		

▲-HOR. CONTROL MONUMENT - NO. 1 - 1000.83 N 179.01 W NO. 2 - 490.05 N 0.00 E
 GRIDS AND COORDINATES FOR ABOVE OBSERVATION WELLS WERE ESTABLISHED IN THE FIELD BY MILLER ENGINEERS USING PLANT CONTROL MONUMENTS 1 & 2.

ELEVATIONS SHOWN HEREON BASED ON U.S.G.S. DATUM (TUOSTAN PLANT DATUM), ADD 0.79'.
 BENCHMARKS - I. NE COR. OF CONC. PAD FOR EXIST. SHED AT SLUDGE BOX, ELEV. 427.5
 2. CHISELED SQUARE, TOP EXIST. DISCHARGE STRUCTURE, ELEV. 410.02

⊗ 6AR - INDICATES OBSERVATION WELL REPAIRED, FIELD LOCATED AND PLOTTED HEREON BY MILLER ENGINEERS, SHEBOYGAN, WIS.
 ⊕ 4-OW INDICATES OBSERVATION WELLS BY OTHERS
 DRAWING UPDATED ON MARCH 28, 1990.

- LEGEND:
- ⊕ Private well completed in bedrock aquifer.
 - ⊗ Private well completed in glacial overburden.
 - ⊗ ⊕ Monitoring well completed in glacial overburden.

- NOTES:
- 1) Private well locations are approximate.
 - 2) Each private well is identified by the street address of the home(s) for which it supplies water. Dual address indicates a shared well.
 - 3) All private wells within the map boundaries may not be shown.

3.				
2.				
1.				
NO.	BY	DATE	REVISION	APP'D
PROJECT WISCONSIN POWER & LIGHT COMPANY EDGEWATER CLOSED ASH DISPOSAL FACILITY NR 140 COMPLIANCE REPORT				
SHEET TITLE CROSS SECTION LOCATOR MAP				
DRAWN BY: PPH		SCALE: 1" = 200'		PROJ. NO. 07683-107
CHECKED BY: SCC				DRWG. NO.
APPROVED BY: SCC				SHEET 1 OF 11
DATE: 2-6-91				
Dames & Moore		BASE MAP SOURCE: Base map provided by Wisconsin Power & Light Company. Originals prepared by Warzyn Engineering.		

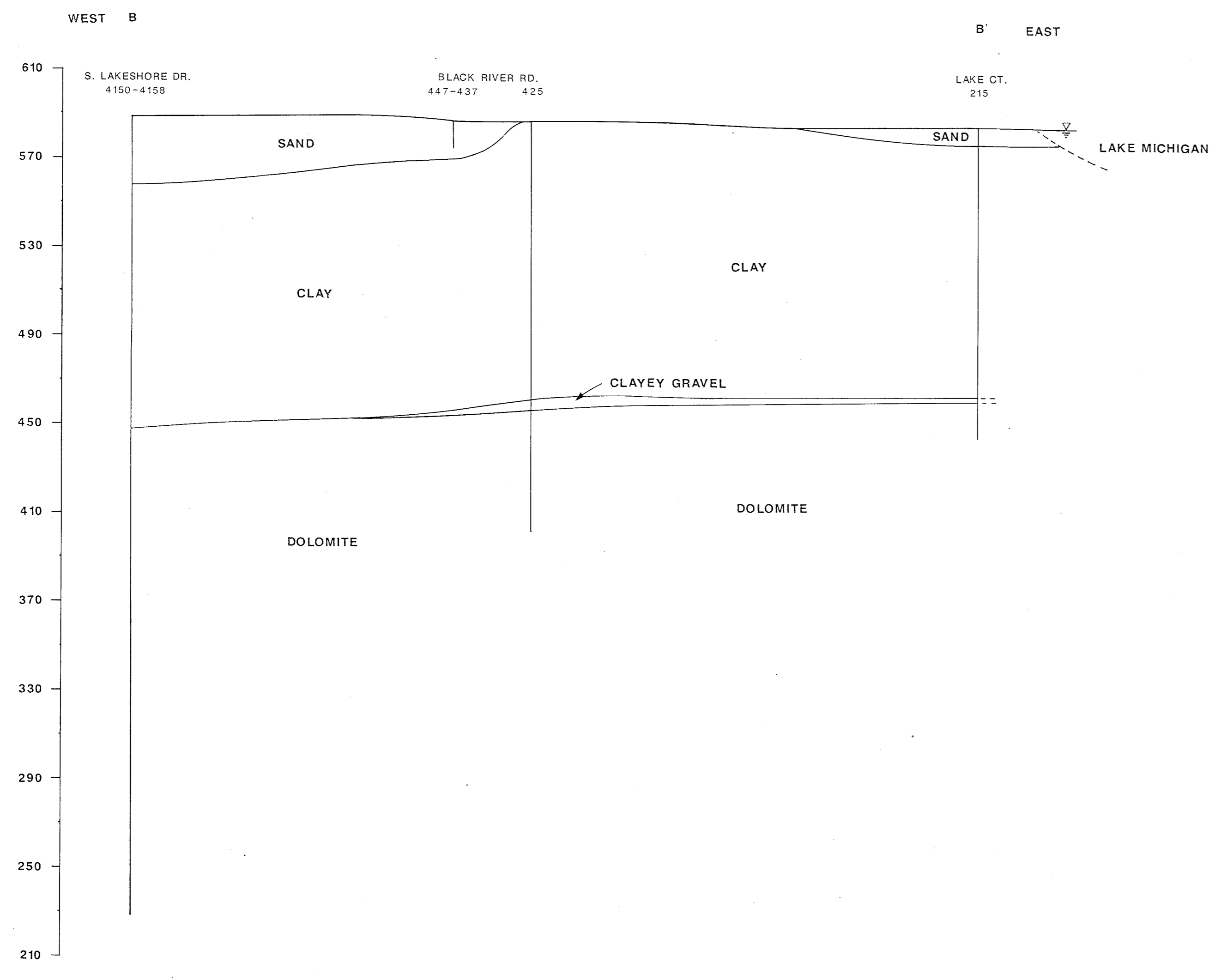
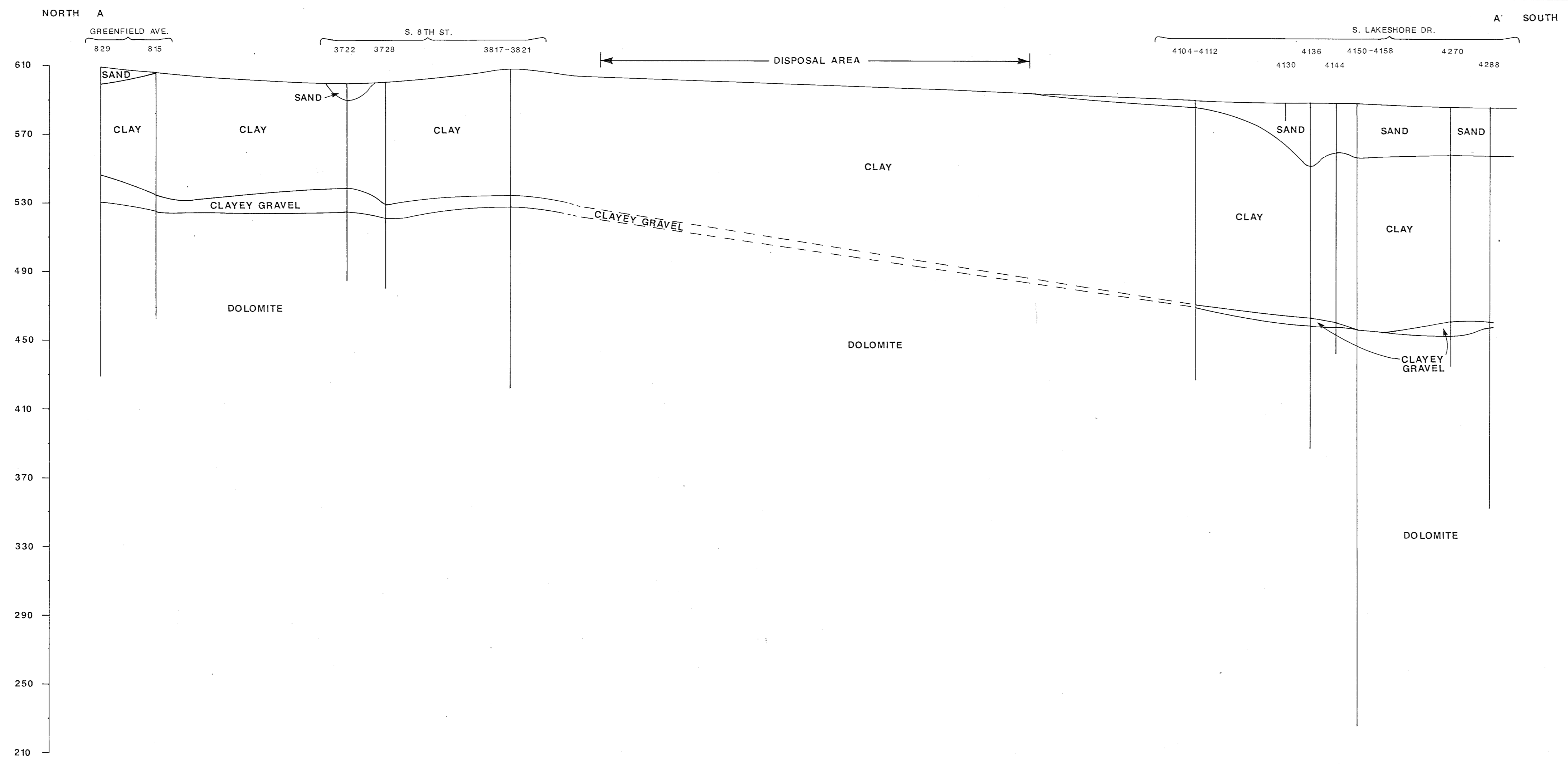

NOTES: 1) Geologic information obtained from well drillers' logs for private wells. Some variations in reported unit thicknesses may reflect differences in logging style or log inaccuracies rather than true geologic variations.
 2) Private well depths are indicated by the vertical lines.

3.				
2.				
1.				
NO.	BY	DATE	REVISION	APP'D
PROJECT: WISCONSIN POWER & LIGHT COMPANY EDGEWATER CLOSED ASH DISPOSAL FACILITY				
SHEET TITLE: GEOLOGIC CROSS SECTIONS A - A' & B - B'				
DRAWN BY: PPH		SCALE: HORIZ. 1"=200'		PROJ. NO. 07683-107
CHECKED BY: soc		VERT. 1"=40'		DRWG. NO.
APPROVED BY: soc				SHEET 2 OF 11
DATE: 2-6-91				

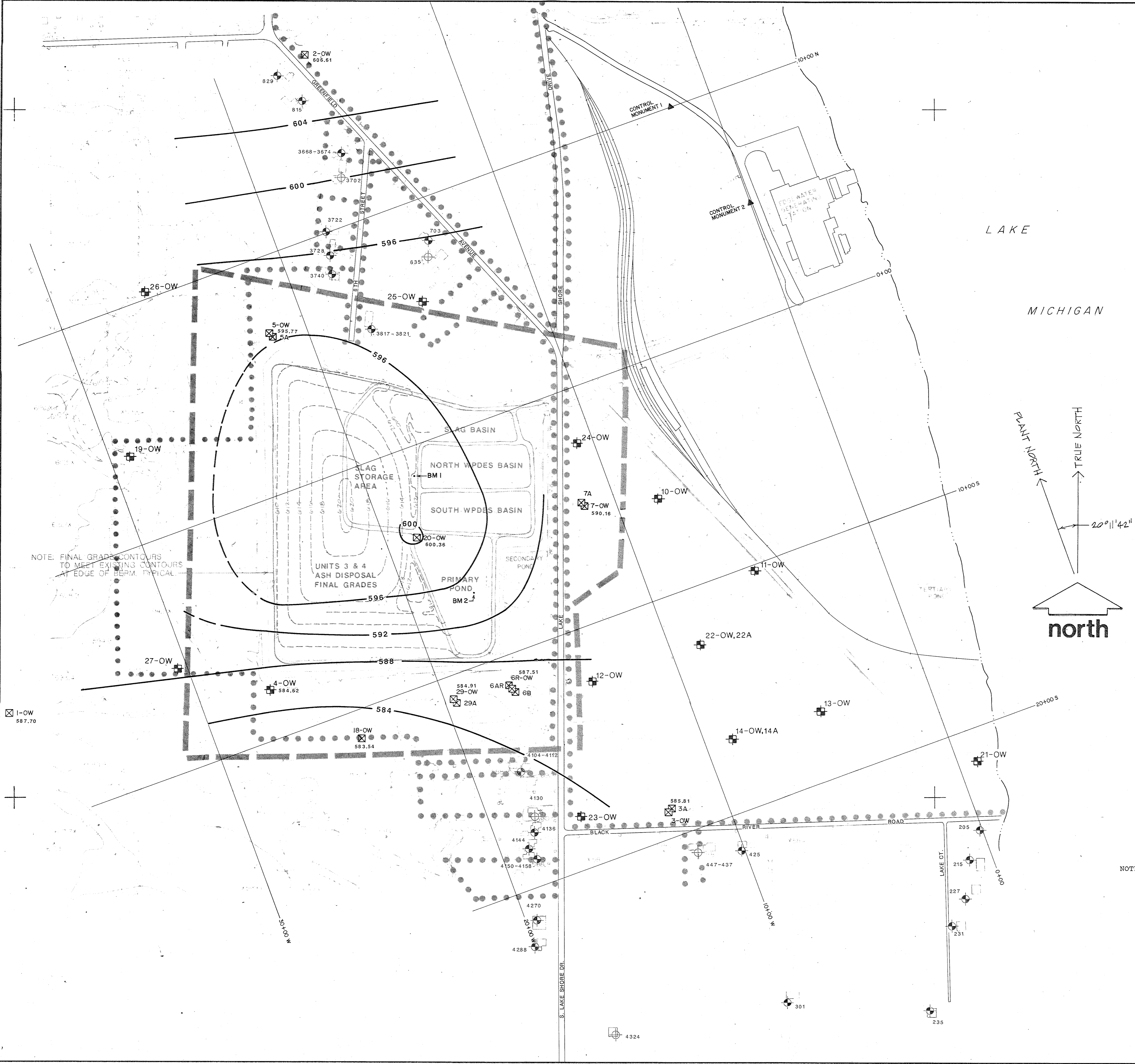

OBSERVATION WELL DATA TABLE

Well Name	Well ID	Well Location	Established	Well Depth	Well Type	Top of Well Casing	Ground Surface	Water Table	Reference	Screen	Length	Material	Well Depth	Other
1-OW	201	489.0 3791.2	X	2-19-76	2"	P	592.53'	590.36	586.55'	✓	5'	Slotted PVC	10.98	✓
2-OW	202	1766.4 1590.1 1883.3	X	2-23-76	2"	P	612.28'	609.75	605.56'	✓	5'	Slotted PVC	11.72	✓
3-OW	203	1242.5 1878.1 1237.4	X	2-17-76	2"	P	591.77'	589.71	585.94'	✓	5'	Slotted PVC	10.83	✓
3A		667.7 2155.2	X	3-22-82	2"	P	592.22'	590.02	582.14'	✓	5'	Slotted PVC	15.08	✓
5-OW	205	661.0 2153.8	X	2-20-76	2"	P	601.77'	599.69	595.23'	✓	4'	Slotted PVC	10.54	✓
5A	206	1135.0	X	2-20-76	2"	P	601.37'	599.41	582.92'	✓	3'	Slotted PVC	21.45	✓
6R-OW		1713.5 1137.4 1705.4	X	2-26-90	2"	P	591.85'	589.17	586.53'	✓	5'	Slotted PVC	10.32	✓
6AR		1138.8 1693.0	X	2-26-90	2"	P	591.34'	589.38	581.74'	✓	5'	Slotted PVC	14.60	✓
6B	209	499.8 1131.5	X	2-19-76	2"	P	591.91'	589.64	578.15'	✓	3'	Slotted PVC	19.75	✓
7-OW	210	490.6 1141.8	X	2-17-76	2"	P	593.76'	591.45	586.61'	✓	4'	Slotted PVC	11.15	✓
7A	211	1116.5 2391.7	X	2-17-76	2"	P	593.90'	591.83	576.44'	✓	3'	Slotted PVC	20.46	✓
18-OW	223	382.3 1873.0	X	6-6-78	2"	P	587.42'	584.99	581.44'	✓	10'	Slotted PVC	15.98	✓
20-OW	220	1093.6 1960.6	X	6-5-78	2"	P	615.80	612.84	583.28	✓	10'	Slotted PVC	42.60	✓
29-OW	224	1096.3 1950.4	X	11-27-84	2"	P	589.13	586.06	580.68	✓	10'	Slotted PVC	18.45	✓
29A	225		X	11-27-84	2"	P	589.21	586.38	548.51	✓	3'	Slotted PVC	43.70	✓

▲-HOR. CONTROL MONUMENT - NO. 1 - 1000.83 N 179.01 W NO. 2 - 490.05 N 0.00 E
 GRIDS AND COORDINATES FOR ABOVE OBSERVATION WELLS WERE ESTABLISHED IN THE FIELD BY MILLER ENGINEERS SHERIDYGAN, WISCONSIN PLANT CONTROL MONUMENTS 1 & 2.

ELEVATIONS SHOWN HEREON BASED ON U.S.G.S. DATUM (TO OBTAIN PLANT DATUM, ADD 0.79).

BENCHMARKS - 1. NE COR. OF CONC. PAD FOR EXIST. SHED AT SLUICE BOX, ELEV. 612.83
 2. CHISELED SQUARE, TOP EXIST. DISCHARGE STRUCTURE, ELEV. 510.62

⊗ 6AR - INDICATES OBSERVATION WELL REPAIRED, FIELD LOCATED AND PLOTTED HEREON BY MILLER ENGINEERS SHERIDYGAN, WISCONSIN.
 ⊕ 4-OW - INDICATES OBSERVATION WELLS BY OTHERS

DRAWING UPDATED ON MARCH 28, 1990.

LEGEND:

- ⊕ Private well completed in bedrock aquifer.
- ⊕ Private well completed in glacial overburden.
- ⊕ ⊗ Monitoring well completed in glacial overburden.
- 587.51 Water table elevation (ft), September 1990
- 600- Water table contour, contour interval 4 feet

- NOTES:**
- Private well locations are approximate.
 - Each private well is identified by the street address of the home(s) for which it supplies water. Dual address indicates a shared well.
 - All private wells within the map boundaries may not be shown.
 - Water level measurements from September 12-13, 1990.

3.				
2.				
1.				
NO.	BY	DATE	REVISION	APP'D
PROJECT				
WISCONSIN POWER & LIGHT COMPANY EDGEWATER CLOSED ASH DISPOSAL FACILITY NR 140 COMPLIANCE REPORT				
SHEET TITLE				
WATER TABLE CONTOUR MAP				
DRAWN BY: PPH		SCALE: 1" = 200'		PROJ. NO. 07683-107
CHECKED BY: SCC				DRWG. NO.
APPROVED BY: SCC				SHEET 3 OF 11
DATE: 2-6-91				
Dames & Moore				
BASE MAP SOURCE: Base map provided by Wisconsin Power & Light Company. Originals prepared by Warzyn Engineering.				

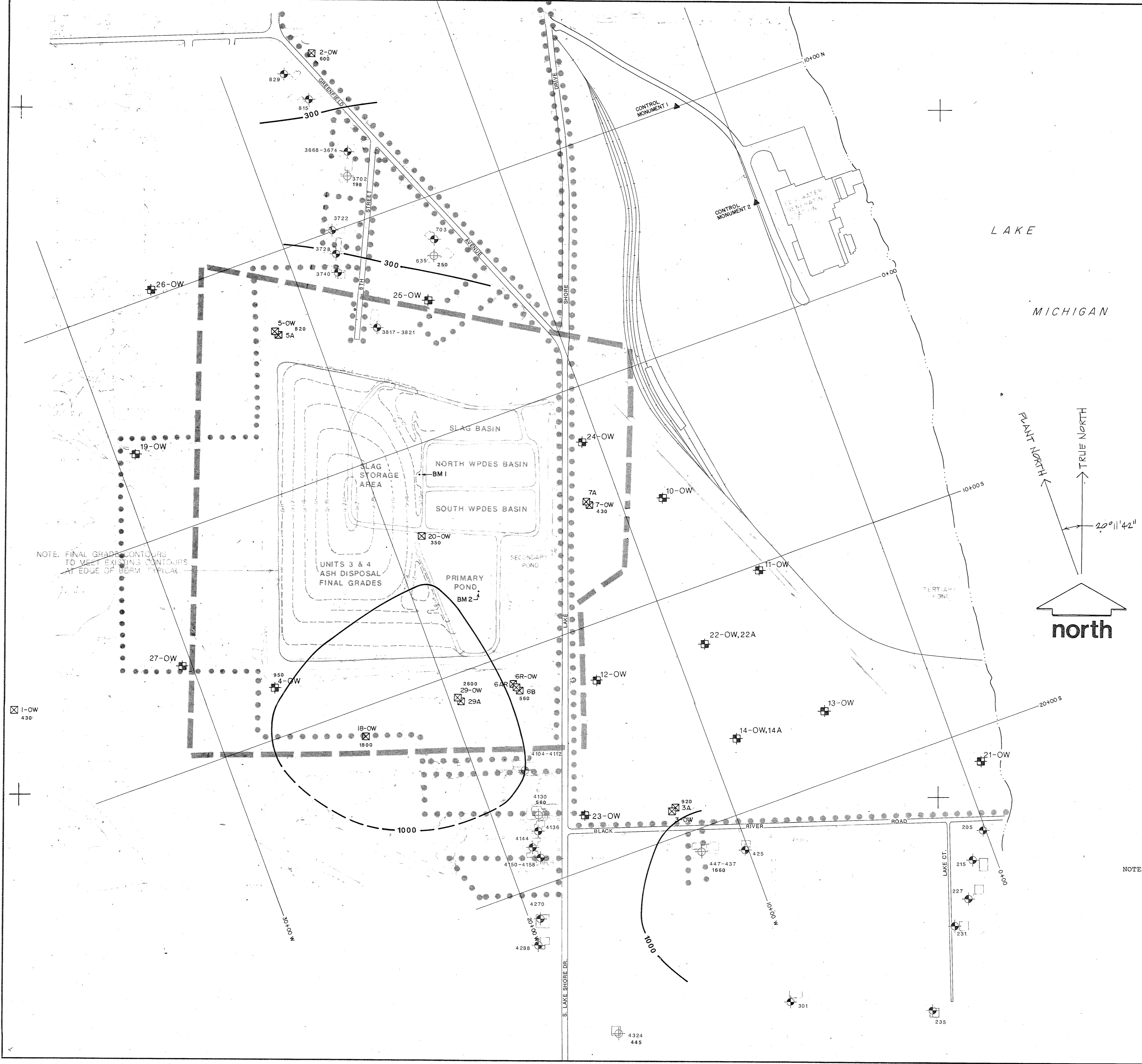

OBSERVATION WELL DATA TABLE

Well Name	Well ID	Well Location	Material	Well Depth	Reference	Remarks
1-OW	201	489.0	PVC	10.98	592.53	
2-OW	202	1766.4	Slotted PVC	11.72	612.28	
3-OW	203	1883.3	Slotted PVC	10.83	591.77	
3A		1237.4	Slotted PVC	15.08	592.22	
5-OW	205	2155.2	Slotted PVC	10.54	601.77	
5A	206	2153.6	Slotted PVC	21.45	601.37	
6R-OW		1135.0	Slotted PVC	10.32	591.85	
6AR		1137.4	Slotted PVC	14.60	591.34	
6B	209	1693.0	Slotted PVC	19.75	591.91	
7-OW	210	499.8	Slotted PVC	11.15	593.76	
7A	211	490.6	Slotted PVC	20.46	593.90	
18-OW	223	1116.5	Slotted PVC	15.98	587.42	
20-OW	220	2391.7	Slotted PVC	42.60	615.88	
29-OW	224	382.3	Slotted PVC	18.45	589.13	
29A	225	1873.0	Slotted PVC	43.7		

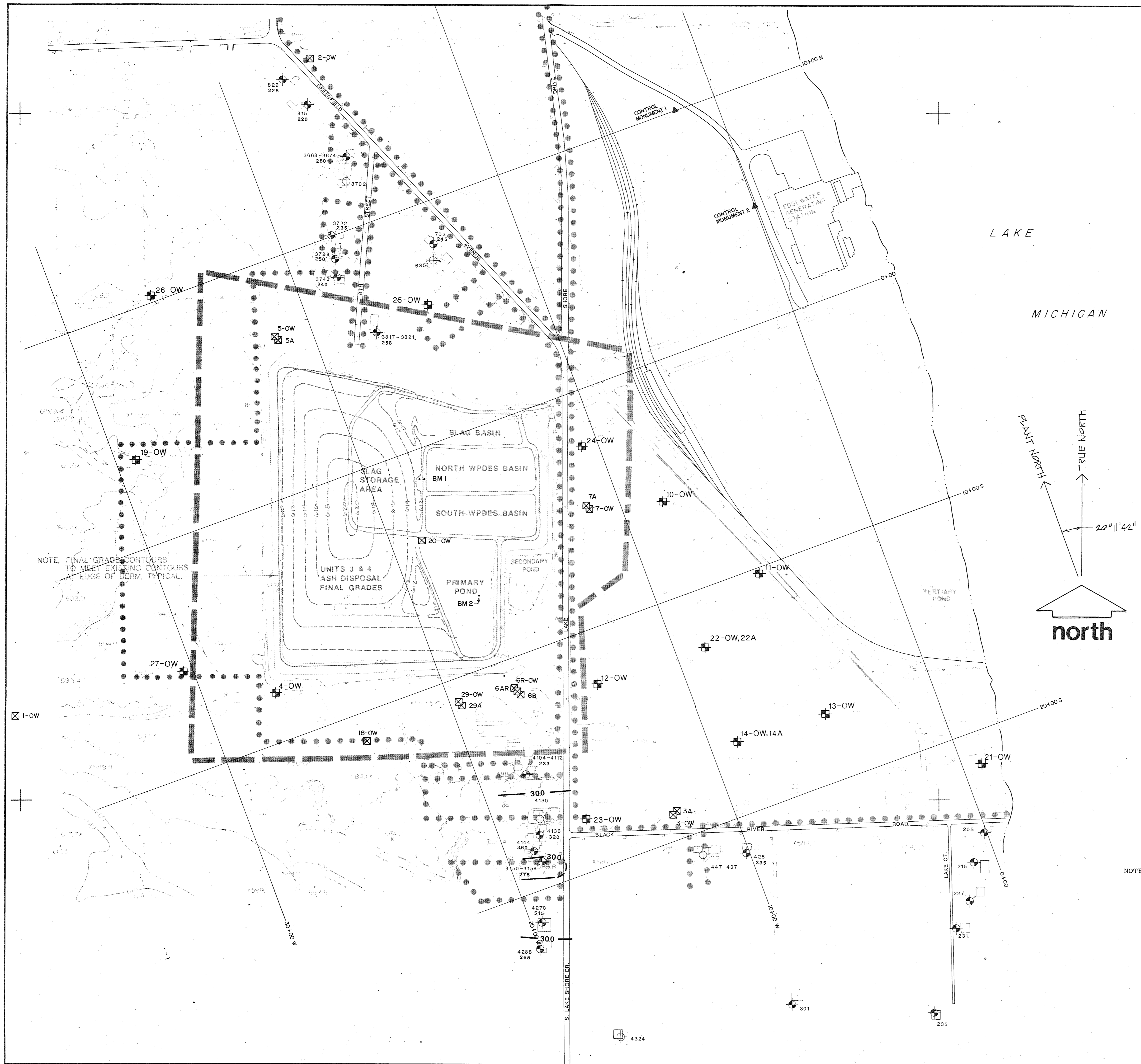

NOTE: FINAL GRADE CONTOURS TO MEET EXISTING CONTOURS AT EDGE OF BERM, TYPICAL.

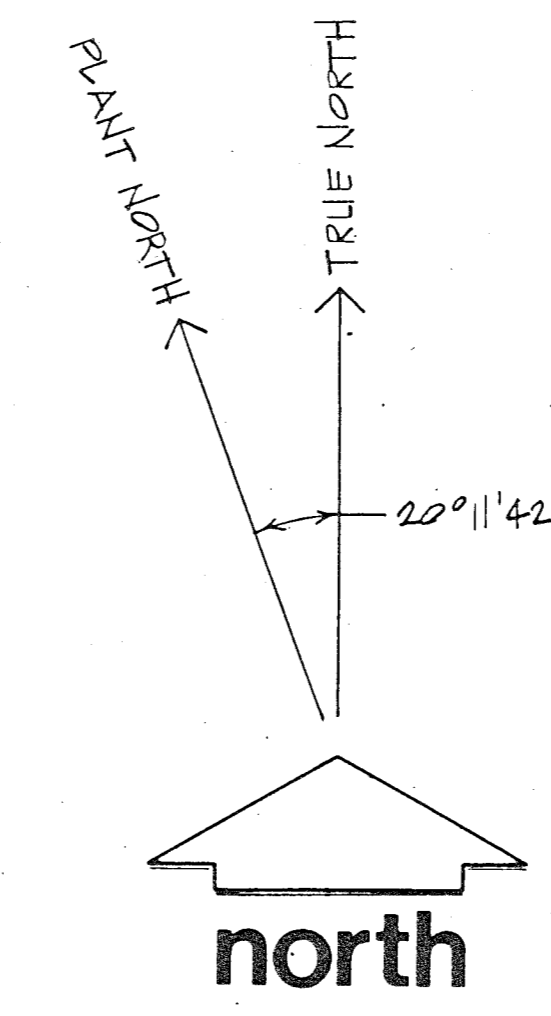

OBSERVATION WELL DATA TABLE

Well Name	Well ID	Well Location	N	S	W	East/West	Well Casing	Depth of Well Casing	Elevation	Screen	Length	Material	Well Depth	Other		
1-OW	201	489.0 3791.2	X	X	X	2-19-76	2"	P	592.53'	590.36	586.55'	✓	5'	Slotted PVC	10.98'	✓
2-OW	202	1766.4 1594.1	X	X	X	2-23-76	2"	P	612.28'	609.75	605.56'	✓	5'	Slotted PVC	11.72'	✓
3-OW	203	1883.3 1242.5	X	X	X	2-17-76	2"	P	591.77'	589.71	585.94'	✓	5'	Slotted PVC	10.83'	✓
3A		1878.1	X	X	X	3-22-82	2"	P	592.22'	590.02	582.14'	✓	5'	Slotted PVC	15.08'	✓
5-OW	205	1237.4 667.7	X	X	X	2-20-76	2"	P	601.77'	599.69	595.23'	✓	4'	Slotted PVC	10.54'	✓
5A	206	661.0 2153.8	X	X	X	2-20-76	2"	P	601.37'	599.41	582.92'	✓	3'	Slotted PVC	21.45'	✓
6R-OW		1135.0 1713.5	X	X	X	2-26-90	2"	P	591.85'	589.17	586.53'	✓	5'	Slotted PVC	10.32'	✓
6AR		1137.4 1705.4	X	X	X	2-26-90	2"	P	591.34'	589.38	581.74'	✓	5'	Slotted PVC	14.60'	✓
6B	209	1138.8 1116.5	X	X	X	2-19-76	2"	P	591.91'	589.64	578.15'	✓	3'	Slotted PVC	19.75'	✓
7-OW	210	499.8 1131.5	X	X	X	2-17-76	2"	P	593.76'	591.45	586.61'	✓	4'	Slotted PVC	11.15'	✓
7A	211	490.6 1141.8	X	X	X	2-17-76	2"	P	593.90'	591.83	576.44'	✓	3'	Slotted PVC	20.46'	✓
18-OW	223	1116.5 -2391.7	X	X	X	6-6-78	2"	P	587.42'	584.99	581.44'	✓	10'	Slotted PVC	15.98'	✓
20-OW	220	382.3 1873.0	X	X	X	6-5-78	2"	P	615.88'	612.84'	583.28'	✓	10'	Slotted PVC	42.60'	✓
29-OW	224	1093.6 1960.6	X	X	X	11-27-84	2"	P	589.13'	586.06'	580.60'	✓	10'	Slotted PVC	18.45'	✓
29A	225	1096.3 1950.4	X	X	X	11-27-84	2"	P	589.21'	586.38'	548.51'	✓	3'	Slotted PVC	43.70'	✓

▲-HOR. CONTROL MONUMENT - NO. 1-1000.83 N 179.01 W NO. 2-490.05 N 0.00 E
GRIDS AND COORDINATES FOR ABOVE OBSERVATION WELLS WERE ESTABLISHED IN THE FIELD BY MILLER ENGINEERS USING PLANT CONTROL MONUMENTS #2.

ELEVATIONS SHOWN HEREON BASED ON U.S.G.S. DATUM (TO OBTAIN PLANT DATUM, ADD 0.79).
BENCHMARKS- 1. NE COR. OF CONC. PAD FOR EXIST. SHED AT SLUDGE BOX, ELEV. 0 2.79
2. CHISELED SQUARE, TOP EXIST. DISCHARGE STRUCTURE, ELEV. 010.02

⊠ 6AR - INDICATES OBSERVATION WELL REPAIRED, FIELD LOCATED AND PLOTTED HEREON BY MILLER ENGINEERS, SHEBOYGAN, WIS. INDICATES OBSERVATION WELLS BY OTHERS.
DRAWING UPDATED ON MARCH 28, 1990.

- LEGEND:
- ⊕ Private well completed in bedrock aquifer.
 - ⊕ Private well completed in glacial overburden.
 - ⊠ Monitoring well completed in glacial overburden.
 - 260 Total dissolved solids concentration (mg/l), September 1990
 - 300 — Concentration contour, contoured on an approximate log interval (... 2, 3, 10, 30, ...)

- NOTES:
- 1) Private well locations are approximate.
 - 2) Each private well is identified by the street address of the home(s) for which it supplies water. Dual address indicates a shared well.
 - 3) All private wells within the map boundaries may not be shown.

3.				
2.				
1.				
NO.	BY	DATE	REVISION	APP'D.
PROJECT: WISCONSIN POWER & LIGHT COMPANY EDGEWATER CLOSED ASH DISPOSAL FACILITY NR 140 COMPLIANCE REPORT				
SHEET TITLE: TDS ISOCONCENTRATION MAP DOLOMITE AQUIFER				
DRAWN BY: PPH		SCALE: 1" = 200'		PROJ. NO. 07683-107
CHECKED BY: SCC		DATE: 2-4-91		DRWG. NO.
APPROVED BY: SCC				SHEET 5 OF 11
Dames & Moore BASE MAP SOURCE: Base map provided by Wisconsin Power & Light Company. Originals prepared by Warzyn Engineering.				

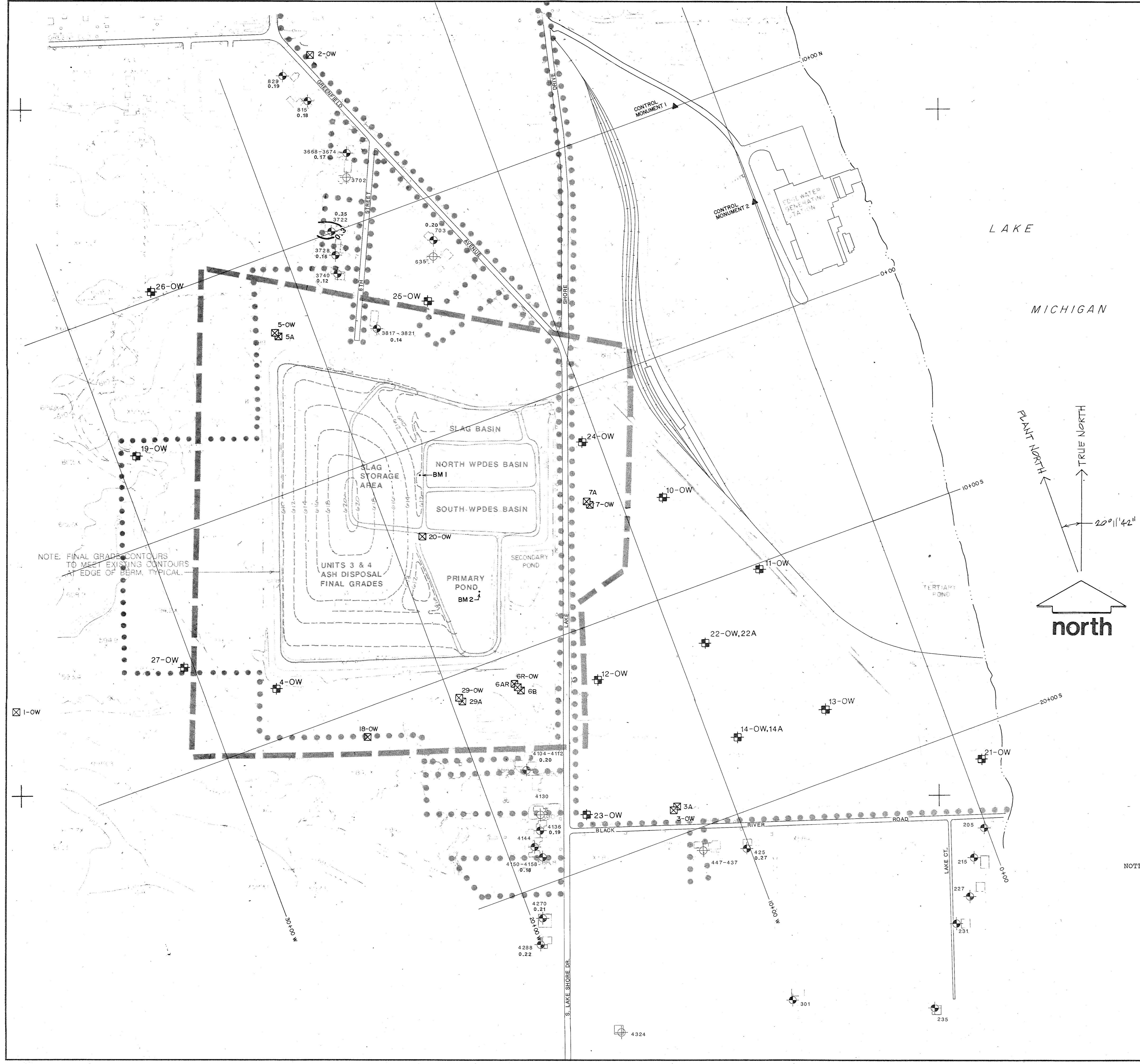

NOTE: FINAL GRADE CONTOURS TO MEET EXISTING CONTOURS AT EDGE OF BERM, TYPICAL.

OBSERVATION WELL DATA TABLE

Well Name	Well ID	Well Location	N	E	W	Established	Depth	Type	Well Casing	Top of Well Casing	Bottom Surface	Elevation	Reference	Length	Material	Well Depth	Other
1-OW	201	489.0	X	X	X	2-19-76	2"	P	592.53'	590.36	586.55	✓	5'	Slotted PVC	10.98	✓	
2-OW	202	3791.2	X	X	X	2-23-76	2"	P	612.28'	609.75	605.56	✓	5'	Slotted PVC	11.72	✓	
3-OW	203	1766.4	X	X	X	2-17-76	2"	P	591.77'	589.71	585.94	✓	5'	Slotted PVC	10.83	✓	
3A		1883.3	X	X	X	3-22-82	2"	P	592.22'	590.02	582.14	✓	5'	Slotted PVC	15.08	✓	
5-OW	205	1878.1	X	X	X	2-20-76	2"	P	601.77'	599.69	595.23	✓	4'	Slotted PVC	10.54	✓	
5A	206	1237.4	X	X	X	2-20-76	2"	P	601.37'	599.41	582.92	✓	3'	Slotted PVC	21.45	✓	
6R-OW		2155.2	X	X	X	2-26-90	2"	P	591.85'	589.17	586.53	✓	5'	Slotted PVC	10.32	✓	
6AR		1135.0	X	X	X	2-26-90	2"	P	591.34'	589.38	581.74	✓	5'	Slotted PVC	14.60	✓	
6B	209	1713.5	X	X	X	2-19-76	2"	P	591.91'	589.64	578.15	✓	3'	Slotted PVC	19.75	✓	
7-OW	210	1137.4	X	X	X	2-17-76	2"	P	593.76'	591.45	586.61	✓	4'	Slotted PVC	11.15	✓	
7A	211	1705.4	X	X	X	2-17-76	2"	P	593.90'	591.83	576.44	✓	3'	Slotted PVC	20.46	✓	
18-OW	223	1138.8	X	X	X	6-6-78	2"	P	587.42'	584.99	581.44	✓	10'	Slotted PVC	15.98	✓	
20-OW	220	1693.0	X	X	X	6-5-78	2"	P	615.88'	612.84	583.28	✓	10'	Slotted PVC	42.60	✓	
29-OW	224	499.0*	X	X	X	11-27-84	2"	P	589.13'	586.06	580.68	✓	10'	Slotted PVC	18.45	✓	
29A	225	1116.5	X	X	X	11-27-84	2"	P	589.21'	586.38	548.51	✓	3'	Slotted PVC	43.70	✓	

▲-HOR. CONTROL MONUMENT - NO. 1 - 1000.03 N 179.01 W NO. 2 - 490.05 N 0.00 E
 GRIDS AND COORDINATES FOR ABOVE OBSERVATION WELLS WERE ESTABLISHED IN THE FIELD BY MILLER ENGINEERS USING PLANT CONTROL MONUMENTS #1 & 2.

ELEVATIONS SHOWN HEREON BASED ON U.S.G.S. DATUM (TO OSTA N PLANT DATUM, ADD. 0.79).

BENCHMARKS - I. NE COR. OF CONC. PAD FOR EXIST. SHED AT SLUICE BOX, ELEV. 0 2.73
 2. CHISELED SQUARE, TOP EXIST. DISCHARGE STRUCTURE, ELEV. 010.02

☒ 6AR - INDICATES OBSERVATION WELL REPAIRED, FIELD LOCATED AND PLOTTED HEREON BY MILLER ENGINEERS SHEBOYGAN, WIS.
 ☒ 4-OW INDICATES OBSERVATION WELLS BY OTHERS
 DRAWING UPDATED ON MARCH 28, 1990.

LEGEND:

- ⊕ Private well completed in bedrock aquifer.
- ⊕ Private well completed in glacial overburden.
- ☒ Monitoring well completed in glacial overburden.
- 0.27 Total boron concentration (mg/l), September 1987
- 0.3 - Concentration contour, contoured on an approximate log interval (... , 1, 3, 10, 30, ...)

- NOTES:**
- 1) Private well locations are approximate.
 - 2) Each private well is identified by the street address of the home(s) for which it supplies water. Dual address indicates a shared well.
 - 3) All private wells within the map boundaries may not be shown.
 - 4) Total boron concentrations for September 1987 were plotted, rather than September 1990, because the 1990 results had a detection limit of 1 mg/l and all results were below detection.

3.				
2.				
1.				
NO.	BY	DATE	REVISION	APP'D
PROJECT WISCONSIN POWER & LIGHT COMPANY EDGEWATER CLOSED ASH DISPOSAL FACILITY NR 140 COMPLIANCE REPORT				
SHEET TITLE BORON ISOCONCENTRATION MAP DOLOMITE AQUIFER				
DRAWN BY: PPH		SCALE: 1" = 200'		PROJ. NO. 07683-107
CHECKED BY: SCC				DRWG. NO.
APPROVED BY: SCC				SHEET 7 OF 11
DATE: 2-1-91				
Dames & Moore		BASE MAP SOURCE: Base map provided by Wisconsin Power & Light Company. Originals prepared by Warzyn Engineering.		

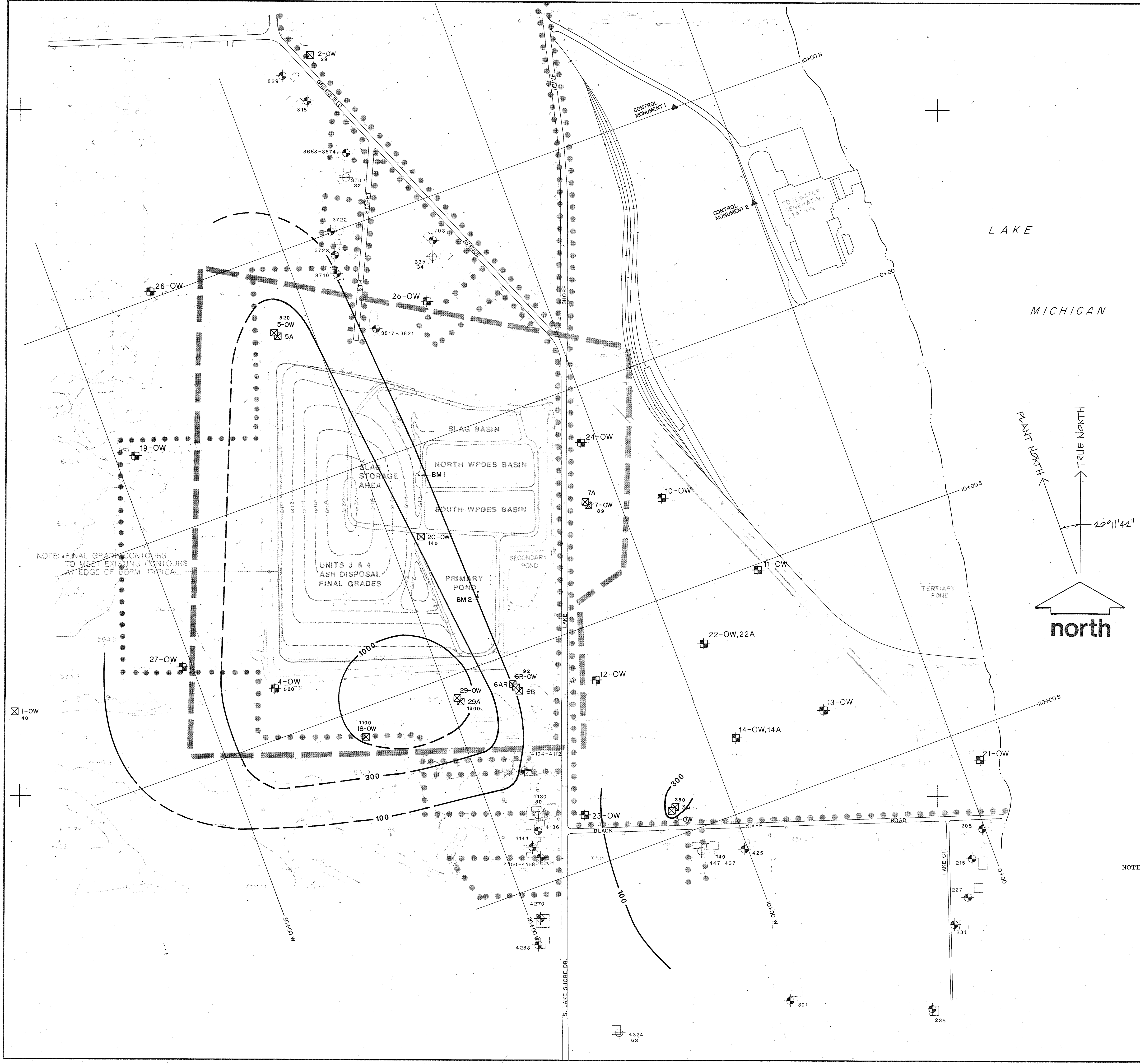

NOTE: FINAL GRADE CONTOURS TO MEET EXISTING CONTOURS AT EDGE OF BERM TYPICAL.

OBSERVATION WELL DATA TABLE

Well Name	Well ID	Well Location	Material	Well Depth	Other
1-OW	201	3791.2	Slotted PVC	10.98	
2-OW	202	1594.1	Slotted PVC	11.72	
3-OW	203	1242.5	Slotted PVC	10.83	
3A		1237.4	Slotted PVC	15.08	
5-OW	205	2155.2	Slotted PVC	10.54	
5A	206	2153.8	Slotted PVC	21.45	
6R-OW		1713.5	Slotted PVC	10.32	
6AR		1705.4	Slotted PVC	14.60	
6B	209	1137.4	Slotted PVC	19.75	
7-OW	210	1131.5	Slotted PVC	11.15	
7A	211	1141.8	Slotted PVC	20.46	
18-OW	223	1116.5	Slotted PVC	15.98	
20-OW	220	382.3	Slotted PVC	42.60	
29-OW	224	1093.6	Slotted PVC	18.45	
29A	225	1096.3	Slotted PVC	43.70	

▲-HOR. CONTROL MONUMENT - NO. 1 - 1000.83 N 179.01 W NO. 2 - 490.05 N 0.00 E
 GRIDS AND COORDINATES FOR ABOVE OBSERVATION WELLS WERE ESTABLISHED IN THE FIELD BY MILLER ENGINEERS USING PLANT CONTROL MONUMENTS 1 & 2.

ELEVATIONS SHOWN HEREON BASED ON U.S.G.S. DATUM (TO OBTAIN PLANT DATUM, ADD 0.79).

BENCHMARKS - 1. NE COR. OF CONC. PAD FOR EXIST. SHED AT SLUDGE BOX, ELEV. 0.275
 2. CHISELED SQUARE, TOP EXIST. DISCHARGE STRUCTURE, ELEV. 0.002

☒ 6AR - INDICATES OBSERVATION WELL REPAIRED, FIELD LOCATED AND PLOTTED HEREON BY MILLER ENGINEERS SHEBOYGAN, WIS.
 ☒ 4-OW INDICATES OBSERVATION WELLS BY OTHERS

DRAWING UPDATED ON MARCH 28, 1990.

- LEGEND:
- ⊕ Private well completed in bedrock aquifer.
 - ⊕ Private well completed in glacial overburden.
 - ⊕ ☒ Monitoring well completed in glacial overburden.
 - 140 Sulfate concentration (mg/l), September 1990
 - 100 - Concentration contour, contoured on an approximate log interval (... 2, 3, 10, 30, ...)

- NOTES:
- 1) Private well locations are approximate.
 - 2) Each private well is identified by the street address of the home(s) for which it supplies water. Dual address indicates a shared well.
 - 3) All private wells within the map boundaries may not be shown.
 - 4) Results shown for monitoring wells are for dissolved sulfate (filtered samples). Results shown for private wells are for total sulfate (unfiltered samples).

3.				
2.				
1.				
NO.	BY	DATE	REVISION	APP'D
PROJECT: WISCONSIN POWER & LIGHT COMPANY EDGEWATER CLOSED ASH DISPOSAL FACILITY NR 140 COMPLIANCE REPORT				
SHEET TITLE: SULFATE ISOCENTRATION MAP GLACIAL AQUIFER				
DRAWN BY: PPH	SCALE: 1" = 200'	PROJ. NO. 07883-107		
CHECKED BY: SCC		DRWG. NO.		
APPROVED BY: SCC		SHEET 8 OF 11		
DATE: 1-6-91				
Dames & Moore BASE MAP SOURCE: Base map provided by Wisconsin Power & Light Company. Originals prepared by Warzyn Engineering.				

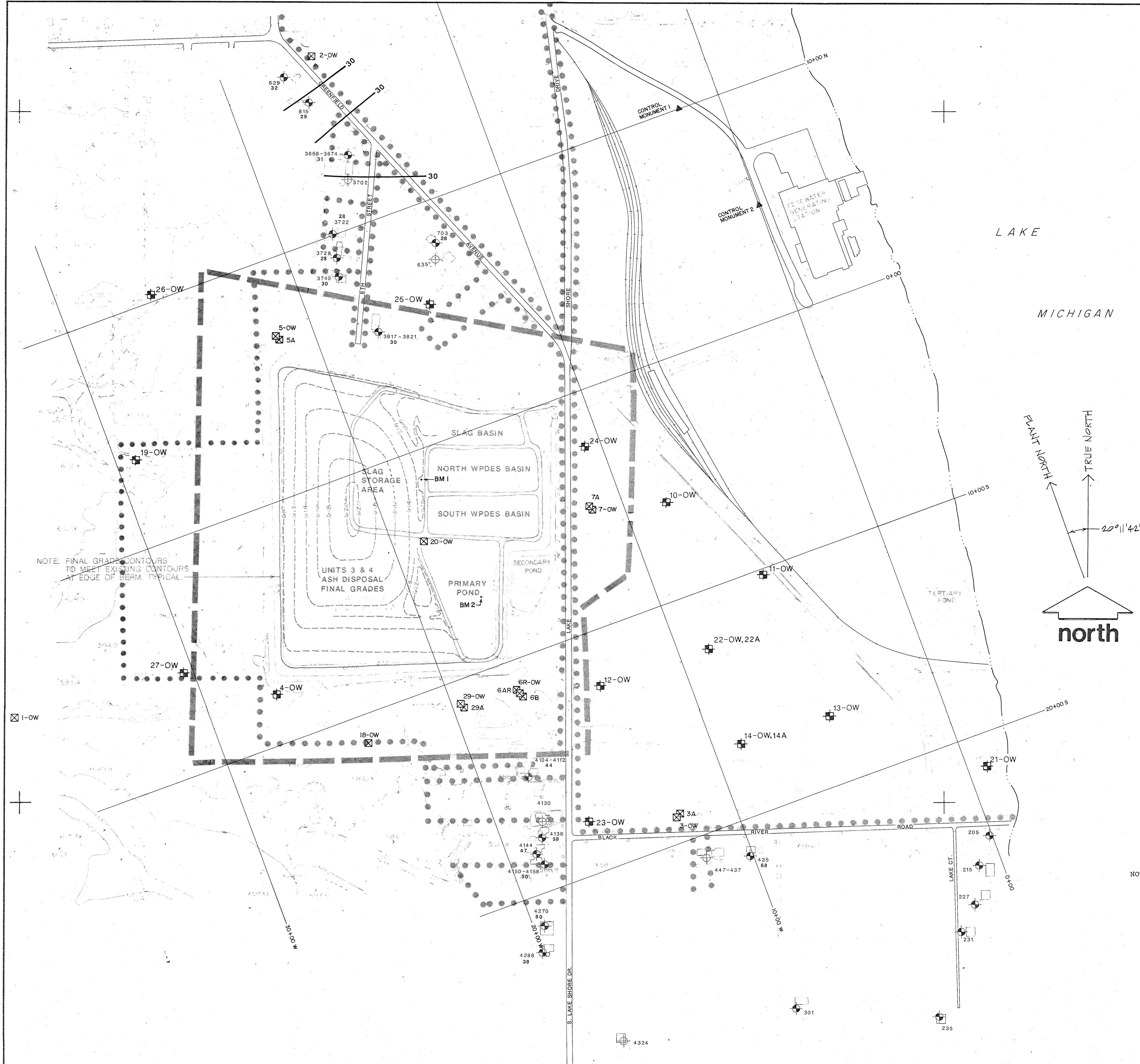

NOTE: FINAL GRADE CONTOURS TO MEET EXISTING CONTOURS AT EDGE OF BERM, TYPICAL.

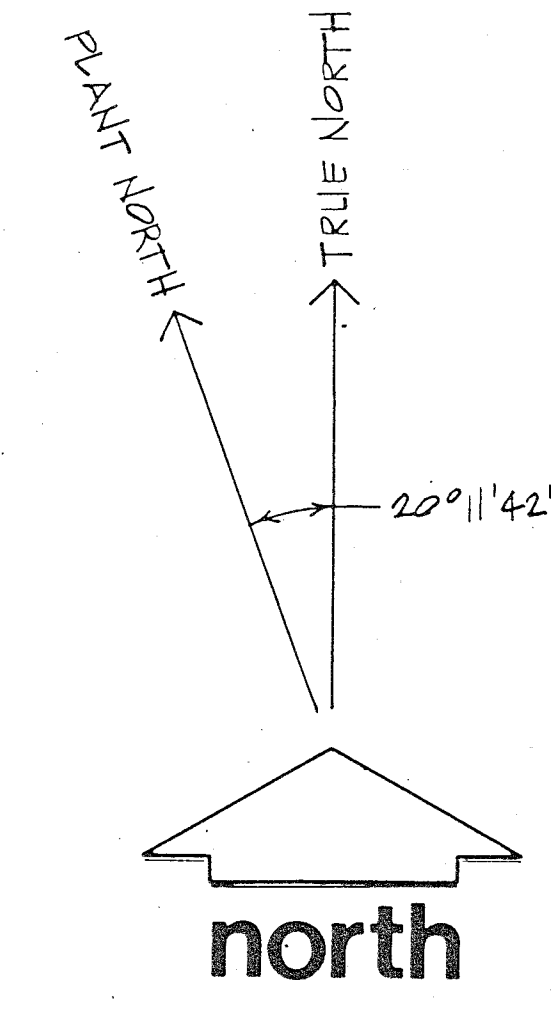

OBSERVATION WELL DATA TABLE

Well Name	Well ID Number	Well Location	Depth	Material	Well Depth	Other
1-OW	201	489.0	2-19-76	2"	P	592.53'
2-OW	202	3791.2	2-23-76	2"	P	612.28'
3-OW	203	1594.1	2-17-76	2"	P	591.77'
3A		1766.4	3-22-82	2"	P	592.22'
5-OW	205	1883.3	2-20-76	2"	P	601.77'
5A	206	1242.5	2-20-76	2"	P	601.37'
6R-OW		1878.1	2-26-90	2"	P	591.85'
6AR		1237.4	2-26-90	2"	P	591.34'
6B	209	2155.2	2-19-76	2"	P	591.91'
7-OW	210	667.7	2-17-76	2"	P	593.76'
7A	211	1135.0	2-17-76	2"	P	593.90'
18-OW	223	1137.4	6-6-78	2"	P	587.42'
20-OW	220	1705.4	6-5-78	2"	P	615.88'
29-OW	224	1138.8	11-27-84	2"	P	589.13'
29A	225	499.8	11-27-84	2"	P	589.21'

▲ - HOR. CONTROL MONUMENT - NO. 1 - 1000.83 N 179.01 W NO. 2 - 490.05 N 0.00 E
 GRIDS AND COORDINATES FOR ABOVE OBSERVATION WELLS WERE ESTABLISHED IN THE FIELD BY MILLER ENGINEERS USING PLANT CONTROL MONUMENTS #1 & 2.

ELEVATIONS SHOWN HEREON BASED ON U.S.G.S. DATUM (TO OBTAIN PLANT DATUM, ADD 0.79).
 BENCHMARKS - 1. NE COR. OF CONC. PAD FOR EXIST. SHED AT SLUICE BOX, ELEV. 0 2.73
 2. 6" BELEED SQUARE, TOP EXIST. DISCHARGE STRUCTURE, ELEV. 010.02

⊠ 6AR - INDICATES OBSERVATION WELL REPAIRED, FIELD LOCATED AND PLOTTED HEREON BY MILLER ENGINEERS SHERIDGAN, WIS.
 ⊠ 4-OW INDICATES OBSERVATION WELLS BY OTHERS
 DRAWING UPDATED ON MARCH 28, 1990.

- LEGEND:**
- ⊕ Private well completed in bedrock aquifer.
 - ⊕ Private well completed in glacial overburden.
 - ⊠ Monitoring well completed in glacial overburden.
 - 88 Total sulfate concentration (mg/l), September 1990
 - 30 — Concentration contour, contoured on an approximate log interval (... 1, 3, 10, 30, ...)

- NOTES:**
- 1) Private well locations are approximate.
 - 2) Each private well is identified by the street address of the home(s) for which it supplies water. Dual address indicates a shared well.
 - 3) All private wells within the map boundaries may not be shown.

3.				
2.				
1.				
NO.	BY	DATE	REVISION	APP'D
PROJECT WISCONSIN POWER & LIGHT COMPANY EDGEWATER CLOSED ASH DISPOSAL FACILITY NR 140 - COMPLIANCE REPORT				
SHEET TITLE SULFATE ISOCONCENTRATION MAP DOLOMITE AQUIFER				
DRAWN BY: PPH		SCALE: 1" = 200'		PROJ. NO. 07883-107
CHECKED BY: SCC				DRWG. NO.
APPROVED BY: SCC				SHEET 9 OF 11
DATE: 2-4-91				
Dames & Moore		BASE MAP SOURCE: Base map provided by Wisconsin Power & Light Company. Originals prepared by Warzyn Engineering.		

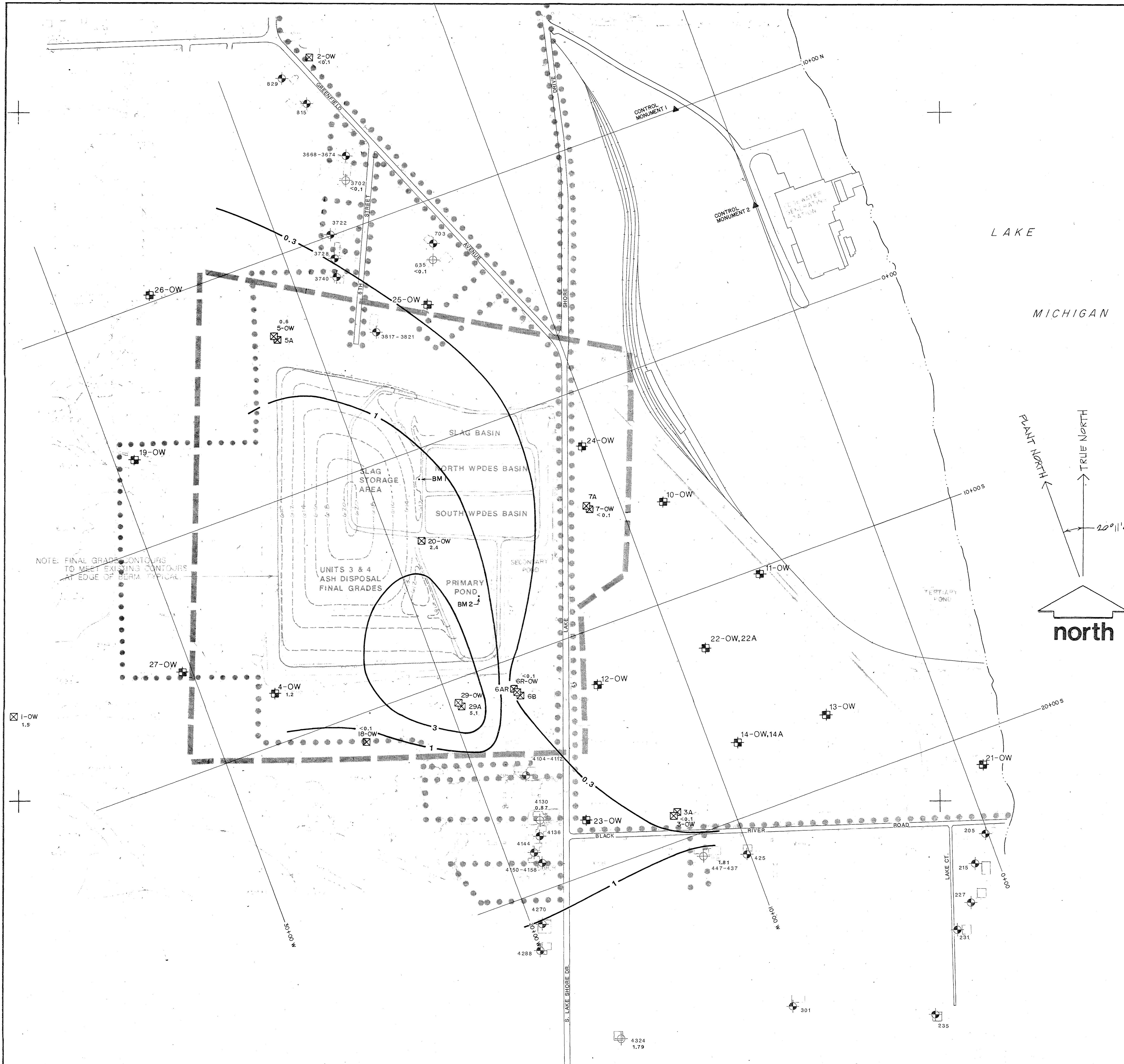

OBSERVATION WELL DATA TABLE

Well Name	UP #	Well Location	Depth	Material	Length	Material	Well Depth	Other	Type of Well							
1-OW	201	3791.2	X	2-19-76	2"	P	592.53'	590.36'	586.55'	✓	5'	Slotted PVC	10.98'	✓		
2-OW	202	1766.4	X	2-23-76	2"	P	612.28'	609.75'	605.56'	✓	5'	Slotted PVC	11.72'	✓		
3-OW	203	1883.3	X	2-17-76	2"	P	591.77'	589.71'	585.94'	✓	5'	Slotted PVC	10.83'	✓		
3A		1237.4	X	3-22-82	2"	P	592.22'	590.02'	582.14'	✓	5'	Slotted PVC	15.08'	✓		
5-OW	205	667.7	X	2-20-76	2"	P	601.77'	599.69'	595.23'	✓	4'	Slotted PVC	10.54'	✓		
5A	206	2153.3	X	2-20-76	2"	P	601.37'	599.41'	582.92'	✓	3'	Slotted PVC	21.45'	✓		
6R-OW		1135.8	X	2-26-90	2"	P	591.85'	589.17'	586.53'	✓	5'	Slotted PVC	10.32'	✓		
6AR		1705.4	X	2-26-90	2"	P	591.34'	589.38'	581.74'	✓	5'	Slotted PVC	14.60'	✓		
6B	209	1138.8	X	2-19-76	2"	P	591.91'	589.64'	578.15'	✓	3'	Slotted PVC	19.75'	✓		
7-OW	210	499.8*	X	2-17-76	2"	P	593.76'	591.45'	586.61'	✓	4'	Slotted PVC	11.15'	✓		
7A	211	490.6	X	2-17-76	2"	P	593.90'	591.83'	576.44'	✓	3'	Slotted PVC	20.46'	✓		
18-OW	223	1116.5	X	6-6-78	2"	P	587.42'	584.99'	581.44'	✓	10'	Slotted PVC	15.98'	✓		
20-OW	220	382.3	X	6-5-78	2"	P	615.88'	612.81'	583.28'	✓	10'	Slotted PVC	42.60'	✓		
29-OW	224	1093.6	X	11-27-84	2"	P	589.13'	586.06'	580.68'	✓	10'	Slotted PVC	18.45'	✓		
29A	225	1950.4	X	11-27-84	2"	P	589.21'	586.38'	548.51'	✓	3'	Slotted PVC	43.70'	✓		

▲-HOR. CONTROL MONUMENT - NO. 1 - 1000.83 N 179.01 W NO. 2 - 490.05 N 0.00 W

GRIDS AND COORDINATES FOR ABOVE OBSERVATION WELLS WERE ESTABLISHED IN THE FIELD BY MILLER ENGINEERS USING PLANT CONTROL MONUMENTS 1 & 2.

ELEVATIONS SHOWN HEREON BASED ON U.S.G.S. DATUM (TUOSTAN PLANT DATUM, ADD 0.79)

BENCHMARKS - 1. NE COR. OF CONC. PAD FOR EXIST. SHED AT SLUICE BOX, ELEV. 0.273
2. 2" BEHELD SQUARE, TOP EXIST. DISCHARGE STRUCTURE, ELEV. 010.02

☒ 6AR - INDICATES OBSERVATION WELL REPAIRED, FIELD LOCATED AND PLOTTED HEREON BY MILLER ENGINEERS (SHERIDYAN, WLD.)
☒ 4-OW INDICATES OBSERVATION WELLS BY OTHERS

DEAWING UPDATED ON MARCH 28, 1990.

- LEGEND:**
- ☒ Private well completed in bedrock aquifer.
 - ⊕ Private well completed in glacial overburden.
 - ☒ Monitoring well completed in glacial overburden.
 - 0.6 Iron concentration (mg/l), September 1990
 - 1 - Concentration contour, contoured on an approximate log interval (... , 1, 3, 10, 30, ...)

- NOTES:**
- 1) Private well locations are approximate.
 - 2) Each private well is identified by the street address of the home(s) for which it supplies water. Dual address indicates a shared well.
 - 3) All private wells within the map boundaries may not be shown.
 - 4) Results shown for monitoring wells are for dissolved iron (filtered samples). Results shown for private wells are for total iron (unfiltered samples).

3.				
2.				
1.				
NO. BY DATE		REVISION		APP'D
PROJECT: WISCONSIN POWER & LIGHT COMPANY EDGEWATER CLOSED ASH DISPOSAL FACILITY NR 140 COMPLIANCE REPORT				
SHEET TITLE: IRON ISOCONCENTRATION MAP GLACIAL AQUIFER				
DRAWN BY: PPH	SCALE: 1" = 200'	PROJ. NO. 07683-107		
CHECKED BY: SCC		DRWG. NO.		
APPROVED BY: SCC		SHEET 10 OF 11		
DATE: 2-6-91				
Dames & Moore BASE MAP SOURCE: Base map provided by Wisconsin Power & Light Company. Originals prepared by Warzyn Engineering.				

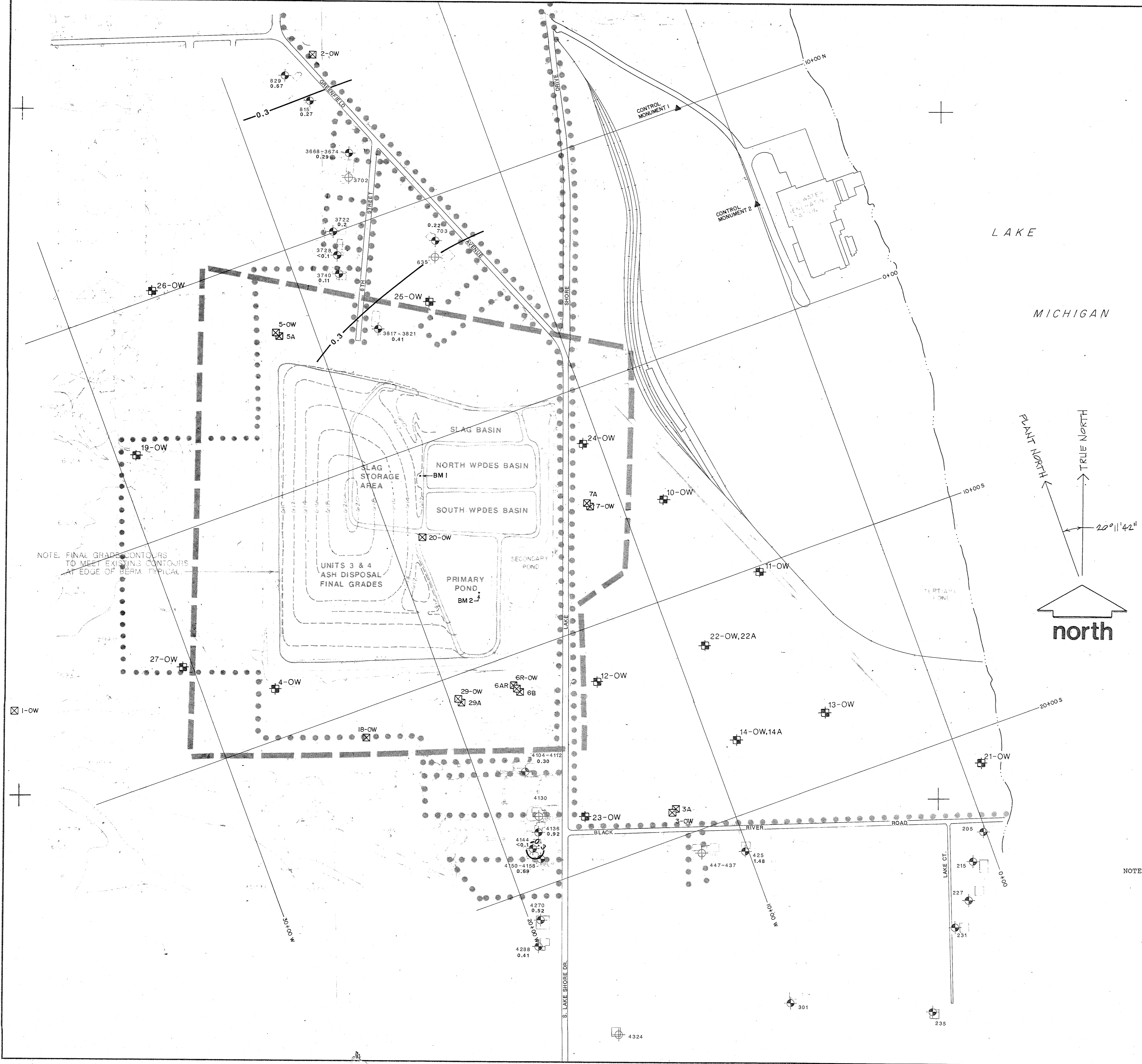

NOTE: FINAL GRADE CONTOURS TO MEET EXISTING CONTOURS AT EDGE OF BERM TYPICAL

OBSERVATION WELL DATA TABLE

Well Name	Well ID	Well Location	Well Depth	Well Type	Well Status	Reference	Material	Well Depth	Type of Well			
1-OW	201	489.0 3791.2 1766.4	2-19-76	2"	P	592.53	590.36	586.55	5'	Slotted PVC	10.98	✓
2-OW	202	1594.1 1883.3	2-23-76	2"	P	612.28	609.75	605.56	5'	Slotted PVC	11.72	✓
3-OW	203	1242.5 1878.1	2-17-76	2"	P	591.77	589.71	585.94	5'	Slotted PVC	10.83	✓
3A		1237.4	3-22-82	2"	P	592.22	590.02	582.14	5'	Slotted PVC	15.08	✓
5-OW	205	667.7 2155.2	2-20-76	2"	P	601.77	599.69	595.23	4'	Slotted PVC	10.54	✓
5A	206	661.0 2153.0	2-20-76	2"	P	601.37	599.41	582.92	3'	Slotted PVC	21.45	✓
6R-OW		1135.0 1713.5	2-26-90	2"	P	591.85	589.17	586.53	5'	Slotted PVC	10.32	✓
6AR		1137.4 1705.4	2-26-90	2"	P	591.34	589.38	581.74	5'	Slotted PVC	14.60	✓
6B	209	1138.8 1693.0	2-19-76	2"	P	591.91	589.64	578.15	3'	Slotted PVC	19.75	✓
7-OW	210	499.8 1131.5	2-17-76	2"	P	593.76	591.45	586.61	4'	Slotted PVC	11.15	✓
7A	211	490.6 1141.8	2-17-76	2"	P	593.90	591.83	576.44	3'	Slotted PVC	20.46	✓
18-OW	223	1116.5 2391.7	6-6-78	2"	P	587.42	584.99	581.44	10'	Slotted PVC	15.98	✓
20-OW	220	382.3 1873.0	6-5-78	2"	P	615.88	612.84	583.28	10'	Slotted PVC	42.60	✓
29-OW	224	1093.6 1960.6	11-27-84	2"	P	589.13	586.06	580.60	10'	Slotted PVC	18.45	✓
29A	225	1096.3 1950.4	11-27-84	2"	P	589.21	586.38	548.51	3'	Slotted PVC	43.70	✓

▲-HOR. CONTROL MONUMENT - NO. 1 - 1000.83 N 179.01 W NO. 2 - 490.05 N 0.00 E
 GRIDS AND COORDINATES FOR ABOVE OBSERVATION WELLS NEXT ESTABLISHED IN THE FIELD BY MILLER ENGINEERS SHERBOGAN, WIS. CONTROL MONUMENTS #2.

ELEVATIONS SHOWN HEREON BASED ON U.S.G.S. DATUM (TO OSTA N. PLANT DATUM, ADD 0.79).
 BENCHMARKS - 1. NE COR. OF CONC. PAD FOR EXIST. SHED AT SLUICE BOX, ELEV. 0.1 TO 2. CHISELED SQUARE, TOP EXIST. DISCHARGE STRUCTURE, ELEV. 0.02

☒ 6AR - INDICATES OBSERVATION WELL REPAIRED, FIELD LOCATED AND PLOTTED HEREON BY MILLER ENGINEERS SHERBOGAN, WIS. INDICATES OBSERVATION WELLS BY OTHERS
 DRAWING UPDATED ON MARCH 28, 1990.

- LEGEND:**
- ⊕ Private well completed in bedrock aquifer.
 - ⊙ Private well completed in glacial overburden.
 - ☒ Monitoring well completed in glacial overburden.
 - 52 Total iron concentration (mg/l), September 1990
 - 0.3- Concentration contour, contoured on an approximate log interval (... , 1, 3, 10, 30, ...)

- NOTES:**
- 1) Private well locations are approximate.
 - 2) Each private well is identified by the street address of the home(s) for which it supplies water. Dual address indicates a shared well.
 - 3) All private wells within the map boundaries may not be shown.

3.				
2.				
1.				
NO.	BY	DATE	REVISION	APP'D
PROJECT: WISCONSIN POWER & LIGHT COMPANY EDGEWATER CLOSED ASH DISPOSAL FACILITY NR 140 COMPLIANCE REPORT				
SHEET TITLE: IRON ISOCONCENTRATION MAP DOLOMITE AQUIFER				
DRAWN BY: PPH		SCALE: 1" = 200'		PROJ. NO. 07683-107
CHECKED BY: SCC				DRWG. NO.
APPROVED BY: SCC				SHEET 11 OF 11
DATE: 2-4-91				
Dames & Moore		BASE MAP SOURCE: Base map provided by Wisconsin Power & Light Company. Prepared by Warzyn Engineering.		

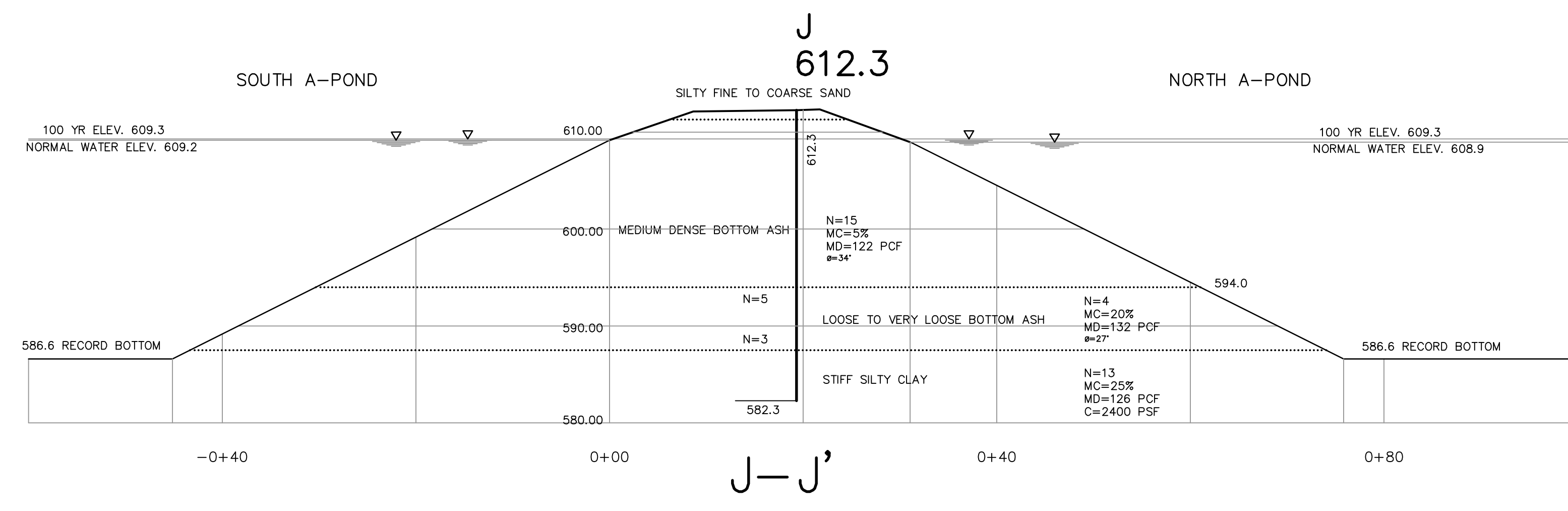
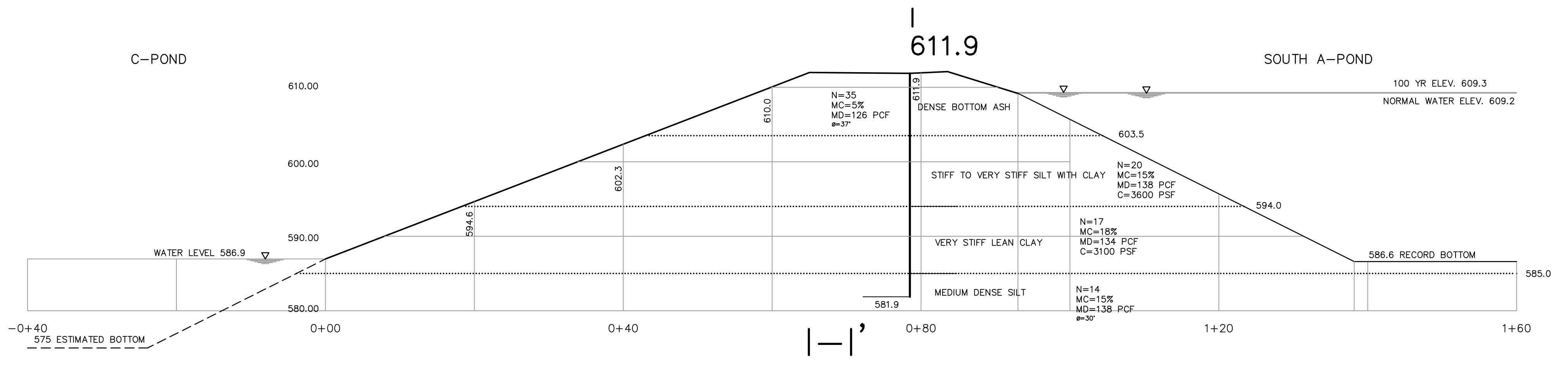
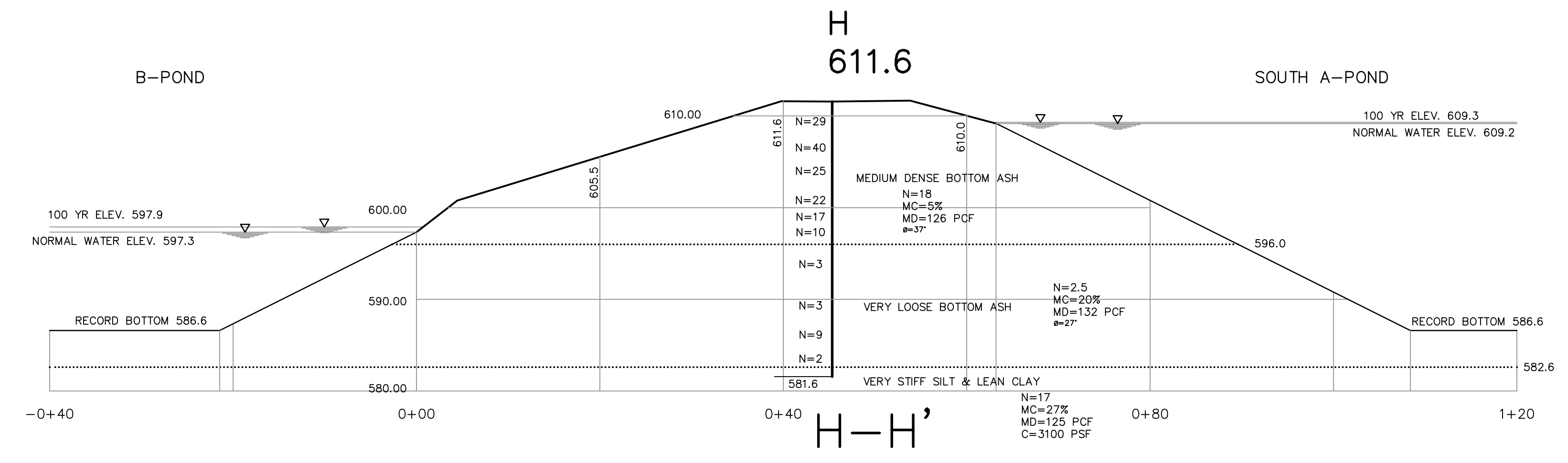
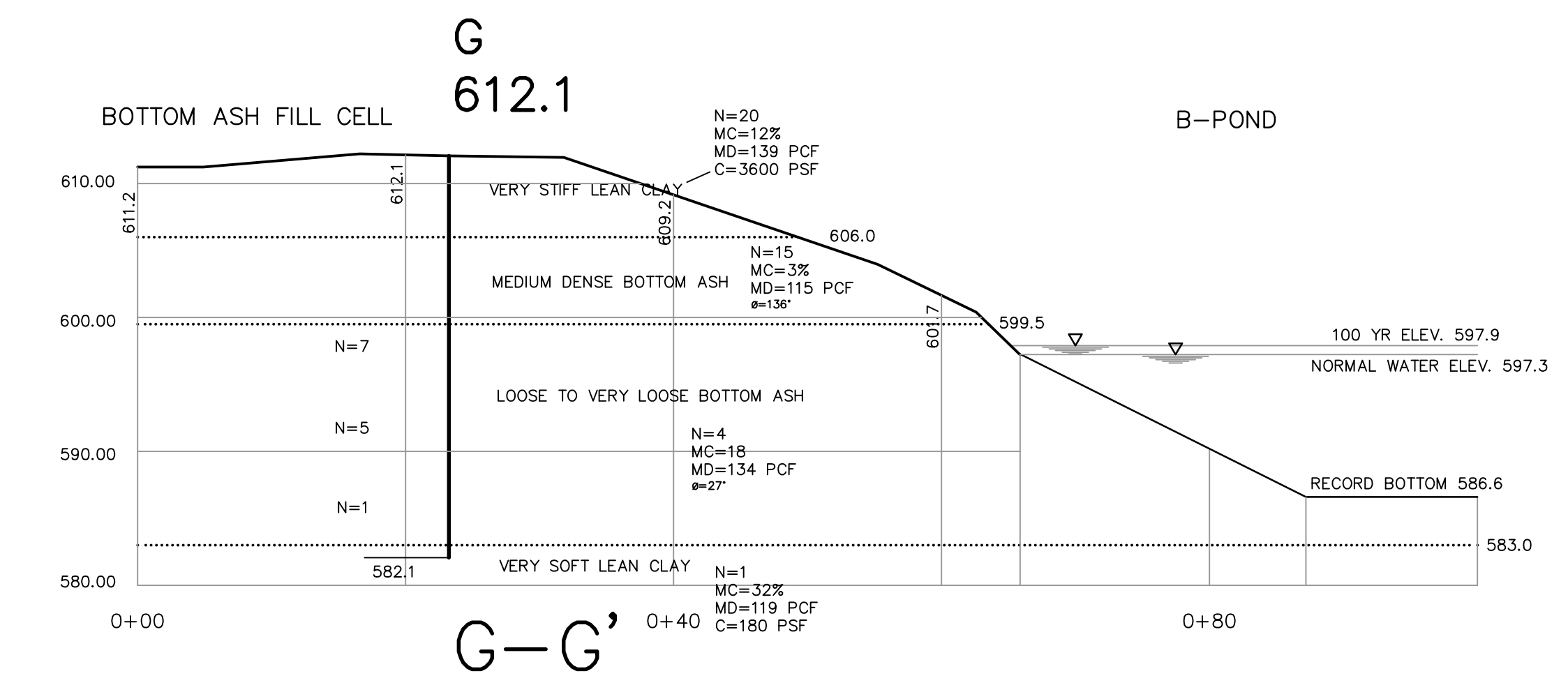
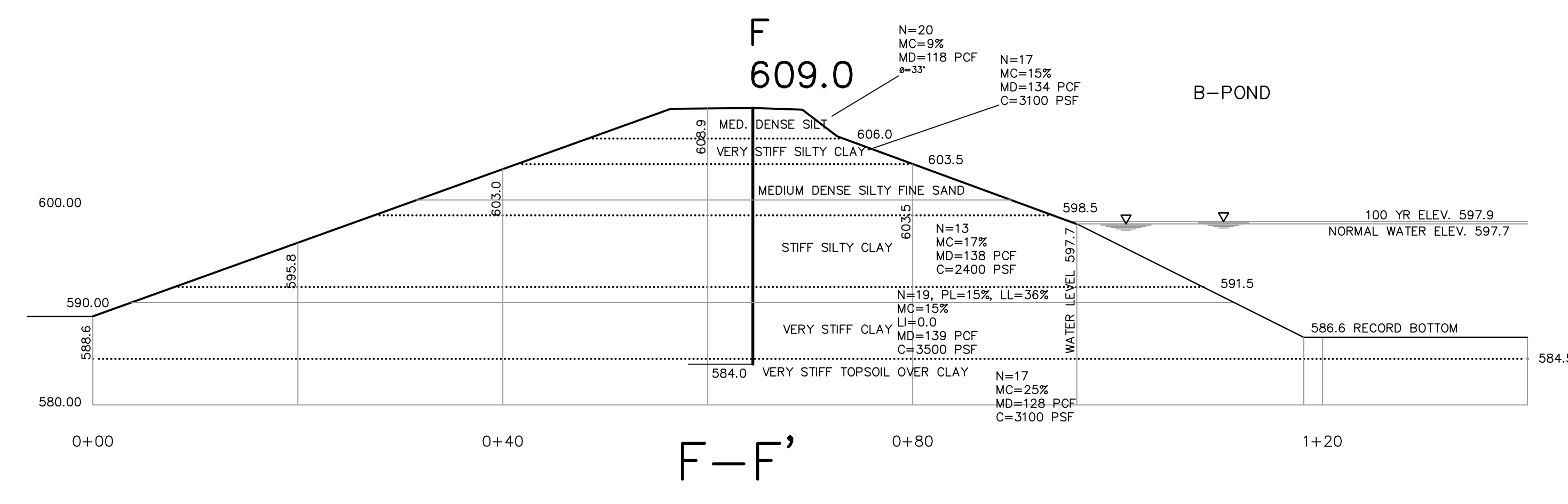
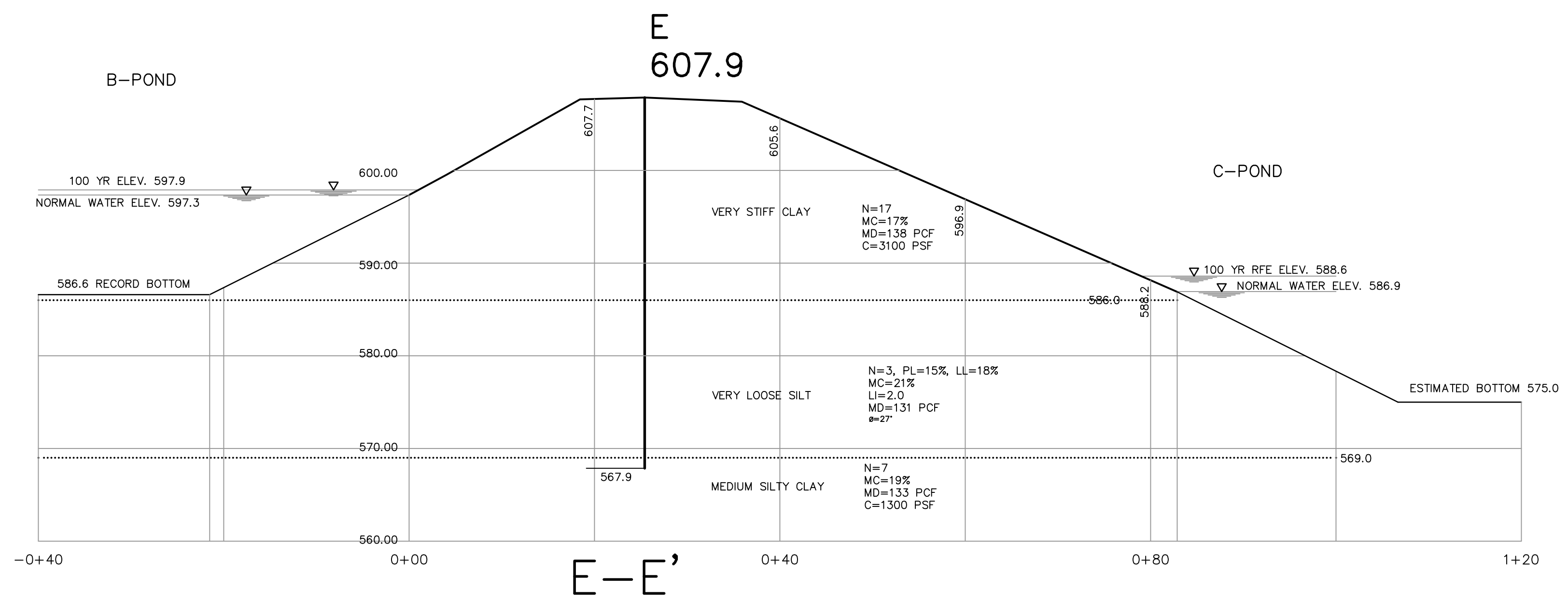

LEGEND

- SOIL LAYER BOUNDARY USED IN STABILITY ANALYSIS
- N = SPT BLOW COUNTS
- MC = SOIL MOISTURE CONTENT
- MD = SOIL MOIST DENSITY
- C = SOIL COHESIVE STRENGTH
- φ = ESTIMATED SOIL INTERNAL ANGLE OF FRICTION

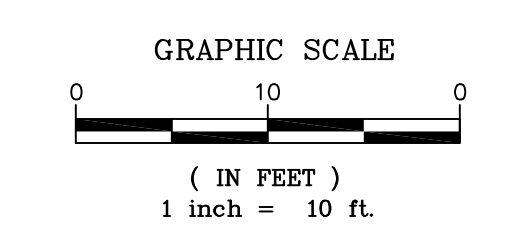

NO.	DATE	DESCRIPTION	BY

CROSS SECTIONS			
EDGEWATER GENERATING STATION			
IMPOUNDMENT ANALYSIS			
	5308 S. 12th Street Sheboygan, WI 53081-8099 Phone 920-458-6164 Fax 920-458-0369 www.StartWithMiller.com		3 OF 5
	SCALE HOR. 1"=10' VER. 1"=10'	DATE FEB. 25, 2011	
ALLIANT ENERGY ASH POND SLOPE STABILITY EVALUATION 3739 LAKE SHORE DRIVE SHEBOYGAN, WISCONSIN			

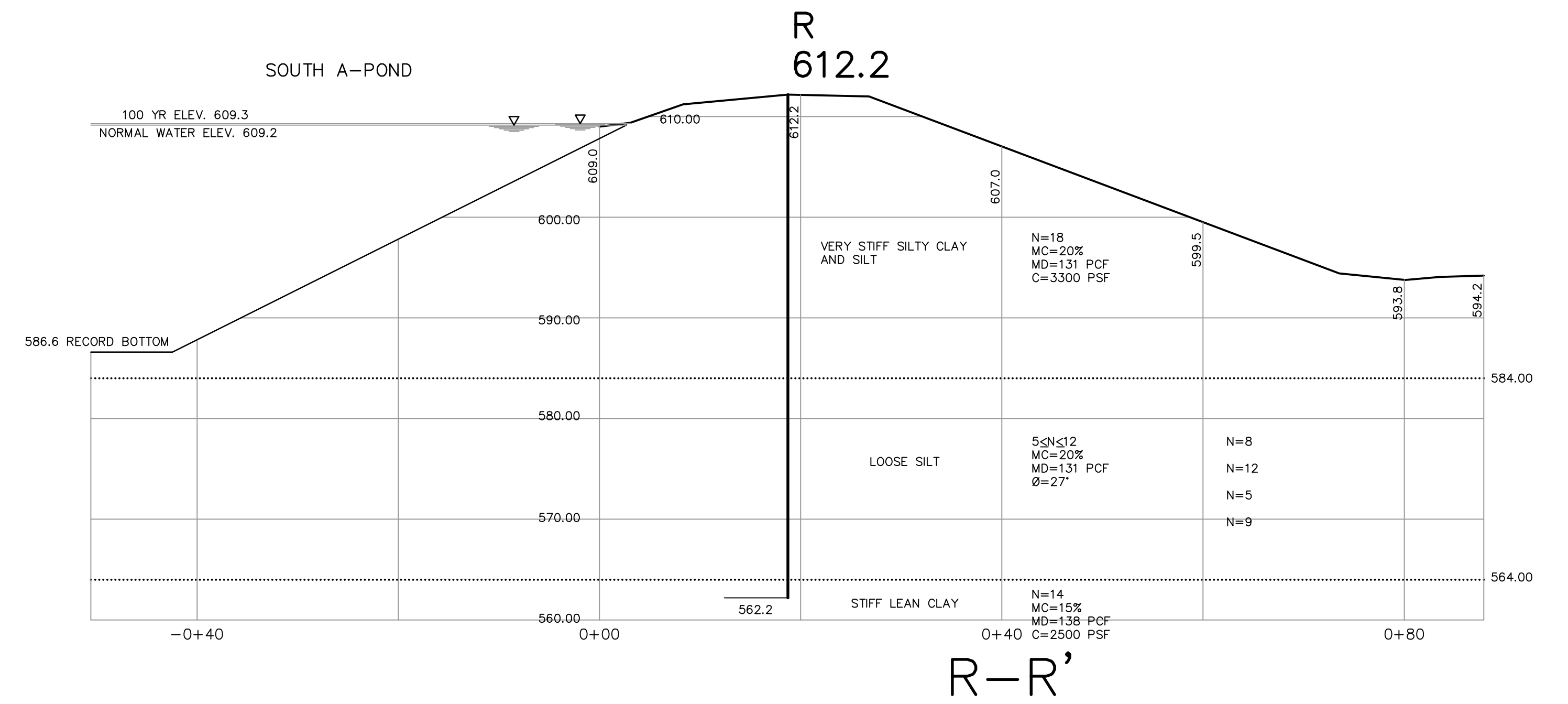
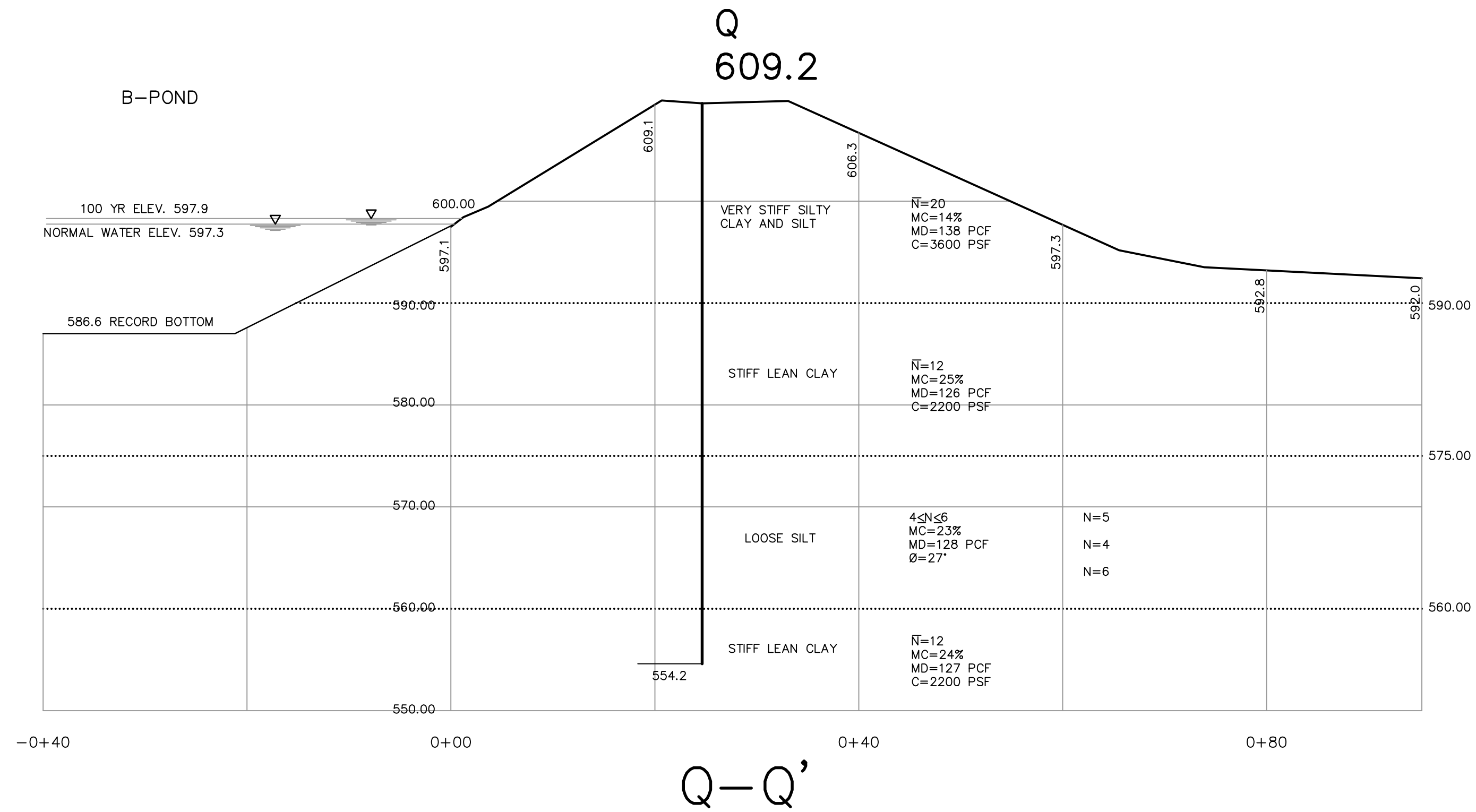

LEGEND

- SOIL LAYER BOUNDARY USED IN STABILITY ANALYSIS
- N= SPT BLOW COUNTS
- MC= SOIL MOISTURE CONTENT
- MD= SOIL MOIST DENSITY
- C= SOIL COHESIVE STRENGTH
- φ = ESTIMATED SOIL INTERNAL ANGLE OF FRICTION

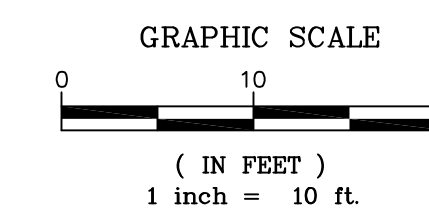

CROSS SECTIONS	
EDGEWATER GENERATING STATION	
IMPOUNDMENT ANALYSIS	
	5308 S. 12th Street Sheboygan, WI 53081-8099 Phone 920-458-6164 Fax 920-458-0369 www.StartWithMiller.com

ALLIANT ENERGY
 ASH POND SLOPE STABILITY EVALUATION
 3739 LAKE SHORE DRIVE
 SHEBOYGAN, WISCONSIN

SCALE	DATE	BY	SHEET
HOR. 1"=10'	Mar. 15, 2011	WGF	5
VER. 1"=10'	JOB	CK	OF
	10-18634-B	RGM	5

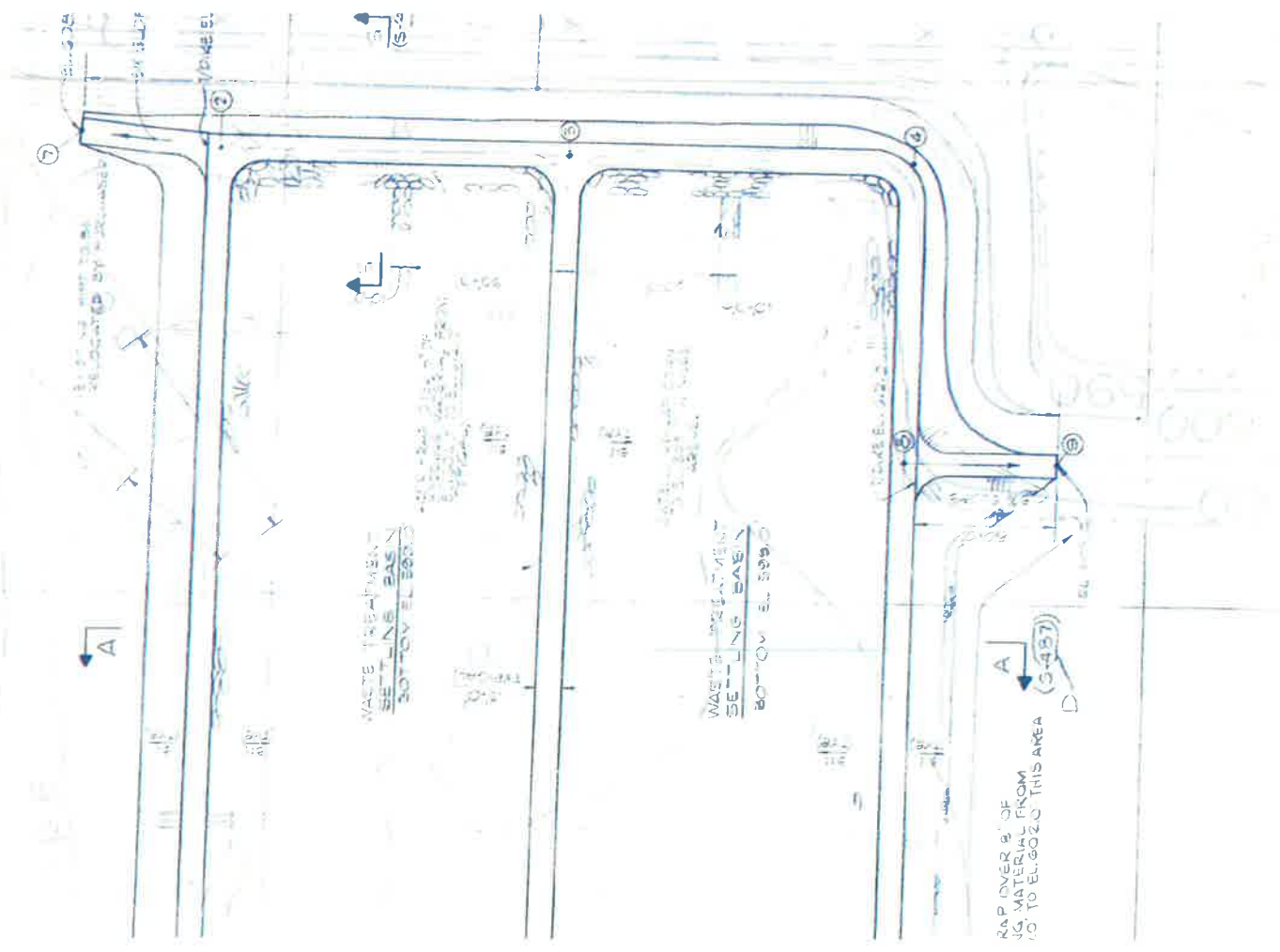

RAP OVER B' OF
JG. MATERIAL FROM
'10 TO EL. 302.0 THIS AREA
(S-437)



WASTE TREATMENT
SETTLING BASIN
BOTTOM ELEV. 307.00

WASTE TREATMENT
SETTLING BASIN
BOTTOM ELEV. 309.00

S-486

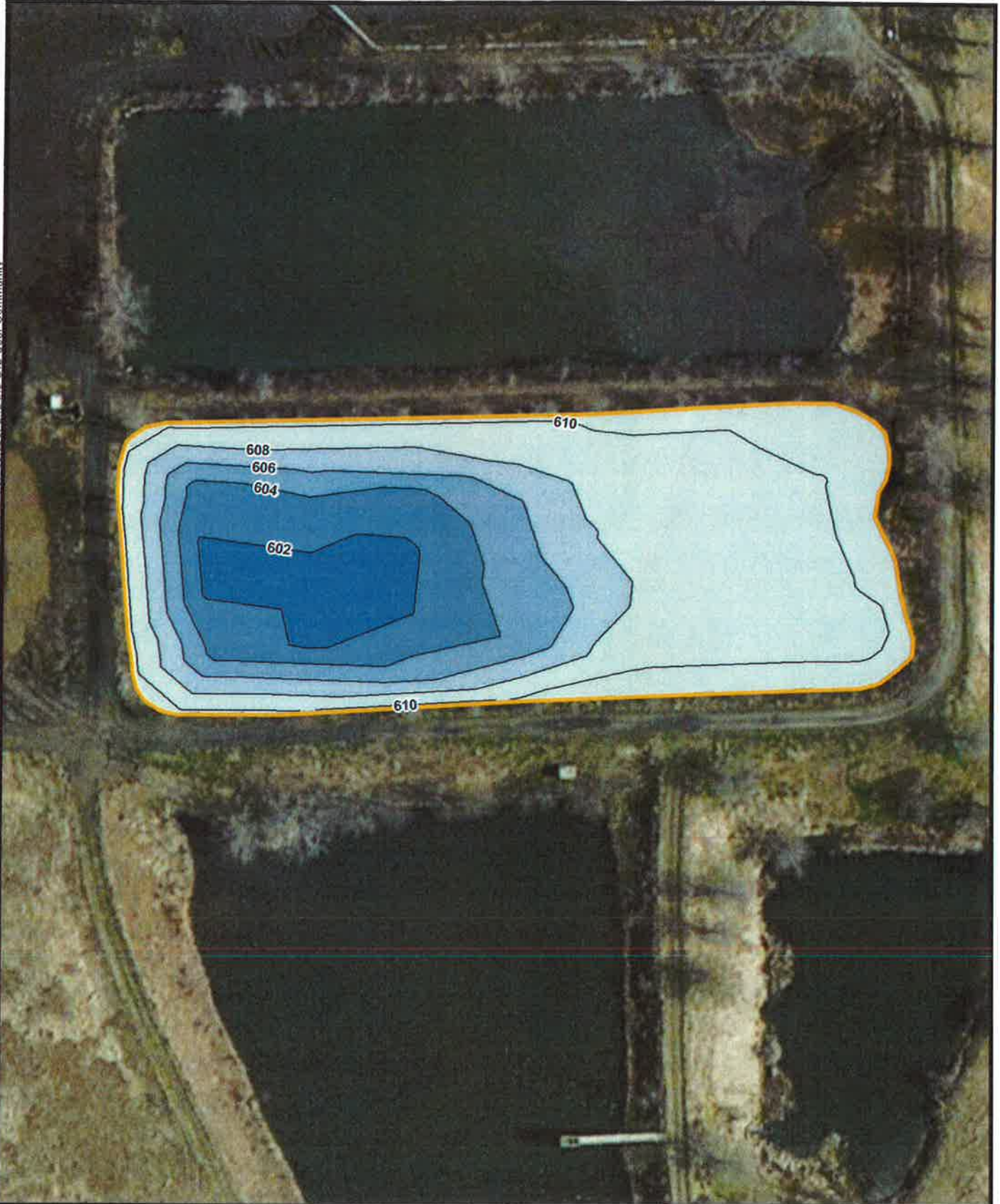
Path: Z:\Clients\ENR\WPL\84143_RiversideTubes\Studies\Site_Invest\EDGEWATER - To Be Moved\GeospatialDataFiles\ArcDocs\Pond_A_Bathymetric.mxd bparker 4/8/2015
 COPYRIGHT © 2015 BURNS & McDONNELL ENGINEERING COMPANY, INC.
 Service Layer Credits: Sources: Esri, DigitalGlobe, GeoEye, Earthstar Geographics, CNES/Airbus DS, USDA, USGS, AFX, Getmapping, Aerotrid, IGN, IGP, swisstopo, and the GIS User Community



<ul style="list-style-type: none"> — Shoreline (WSEL 610.5') Contour (feet) 	<p>Elevation in feet</p> <table border="0"> <tr><td> 601 - 602</td></tr> <tr><td> 602 - 604</td></tr> <tr><td> 604 - 606</td></tr> <tr><td> 606 - 608</td></tr> <tr><td> 608 - 610.5</td></tr> </table>	 601 - 602	 602 - 604	 604 - 606	 606 - 608	 608 - 610.5	<div style="text-align: center;">  <p>NORTH</p> </div> <div style="text-align: center;"> <p>0 40 80</p>  <p>Scale in Feet</p> </div>	<div style="text-align: center;">  <p>BURNS MCDONNELL</p> </div> <div style="text-align: center; margin-top: 20px;"> <p>Pond A Bathymetric Map Alliant Sheboygan County, WI</p> </div>
 601 - 602								
 602 - 604								
 604 - 606								
 606 - 608								
 608 - 610.5								

Path: Z:\Clients\ENR\WPL184143_Riverside\Tubes\Studies\Site_Invest\EDGEWATER - To Be Moved\Geospatial\DataFiles\ArcDocs\Pond_A_SedThickness.mxd bparke 4/8/2015
 COPYRIGHT © 2015 BURNS & McDONNELL ENGINEERING COMPANY, INC.
 Service Layer Credits: Source: Esri, DigitalGlobe, GeoEye, Earthstar Geographics, CNES/Airbus DS, USDA, USGS, AFX, Gattamio, AeroGRID, IGN, IGP, swisstopo, and the GIS User Community

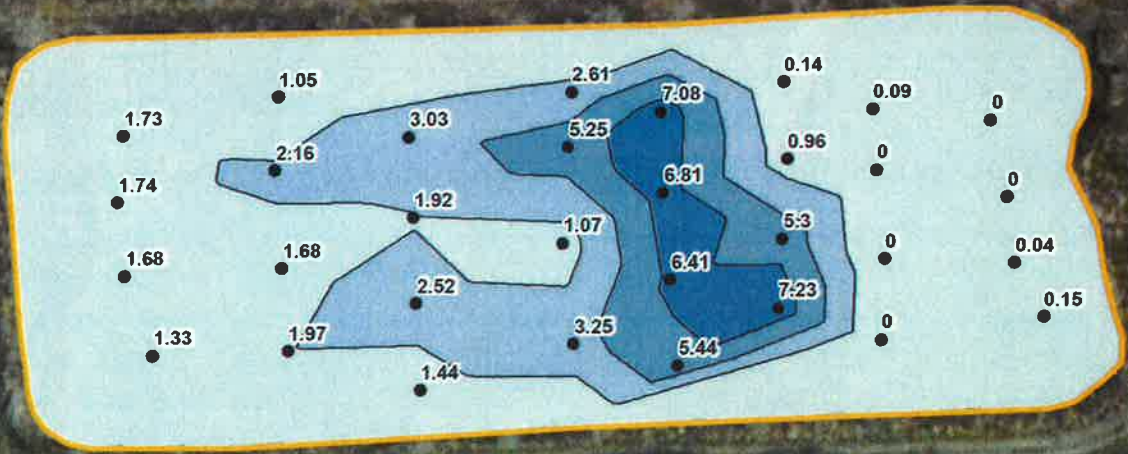

● Depth Probe Locations (feet)	Thickness in feet	 0 40 80 Scale in Feet							
— Shoreline (WSEL 610.5')	<table border="0"> <tr><td></td><td>0 - 2</td></tr> <tr><td></td><td>2 - 4</td></tr> <tr><td></td><td>4 - 6</td></tr> <tr><td></td><td>6 - 7.2</td></tr> </table>			0 - 2		2 - 4		4 - 6	
	0 - 2								
	2 - 4								
	4 - 6								
	6 - 7.2								



Pond A
 Sediment Thickness
 Alliant
 Sheboygan County, WI

Path: Z:\Clients\ENR\WPL184143_River\sideTubes\Studies\Site_Invest\EDGEWATER - To Be Moved\Geospatial\DataFiles\ArcDocs\Pond_B_Bathymetric.mxd bparker 4/8/2015
 COPYRIGHT © 2015 BURNS & McDONNELL ENGINEERING COMPANY, INC.
 Service Layer Credits: Source: Esri, DigitalGlobe, GeoEye, Earthstar Geographics, CNES/Airbus DS, USDA, USGS, AEX, Getmapping, Aerogrid, IGN, IGP, swisstopo, and the GIS User Community

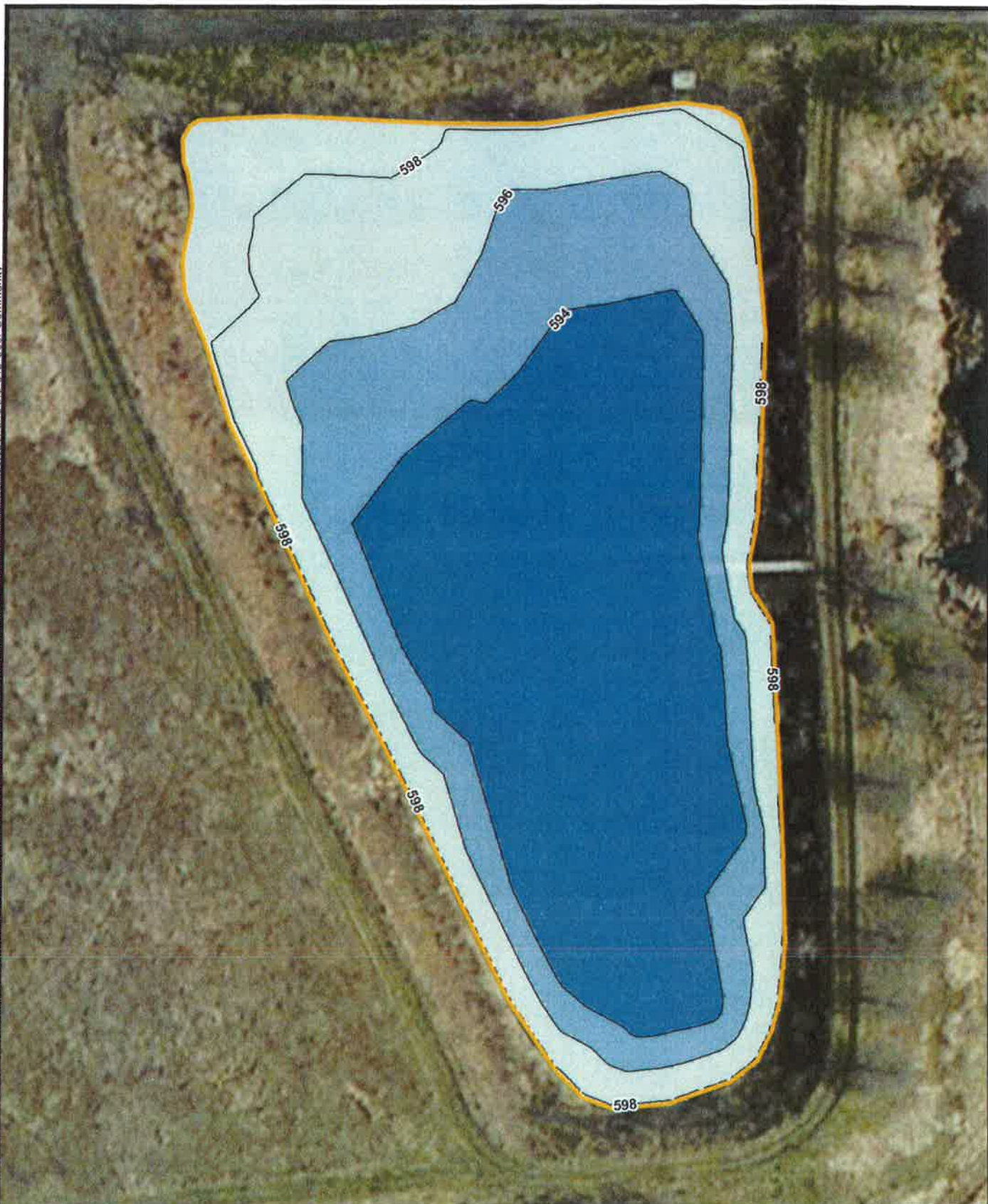

— Shoreline (WSEL 598.2')

— Contour (feet)

Elevation in feet	
	592 - 594
	594 - 596
	596 - 598.2



Pond B
 Bathymetric Map
 Alliant
 Sheboygan County, WI

Path: Z:\Clients\ENRW\PL184143_RiversideTubes\Studies\Site_Invest\EDGEWATER - To Be Moved\GeospatialDataFiles\ArcDocs\Pond_B_SedThickness.mxd bparker 4/8/2015
 COPYRIGHT © 2015 BURNS & McDONNELL ENGINEERING COMPANY, INC.
 Service Level Credits: Source: Esri, DigitalGlobe, GeoEye, Earthstar Geographics, CNES/Airbus DS, USDA, USGS, AFX, Getmapping, Aerogrid, IGN, IGP, swisstopo, and the GIS User Community

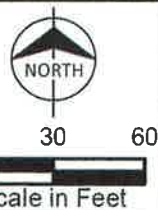
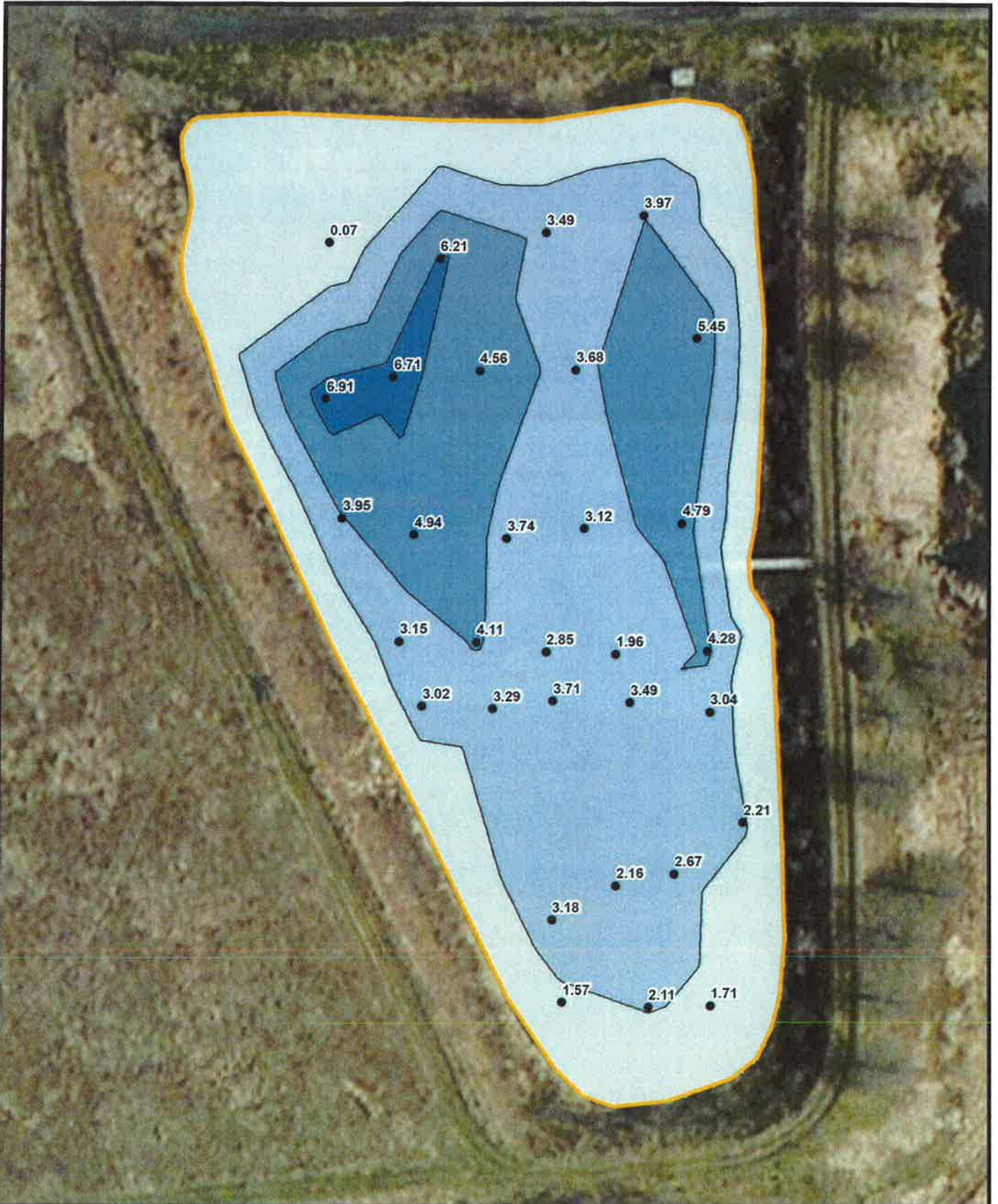

Pond B
 Sediment Thickness
 Alliant
 Sheboygan County, WI